

Shenzhen SOFAR SOLAR Co., Ltd.

TEST REPORT

SCOPE OF WORK

EMC TESTING– HYD 6000-EP, HYD 5500-EP, HYD 5000-EP,
HYD 4600-EP, HYD 4000-EP, HYD 3680-EP, HYD 3000-EP

REPORT NUMBER

201015064GZU-001

ISSUE DATE

05-February-2021

[REVISED DATE]

[-----]

PAGES

53

DOCUMENT CONTROL NUMBER

EN 61000-6-1, 6-3-b

© 2017 INTERTEK



TEST REPORT

Applicant Name & Address : Shenzhen SOFARSOLAR Co., Ltd.
401, Building 4, AnTongDa Industrial Park, District 68, XingDong
Community, XinAn Street, BaoAn District, Shenzhen, China
Manufacturing Site : Dongguan SOFAR SOLAR Co., Ltd.
1F-6F, Building E, No.1 JinQi Road, Bihu Industrial Park, Wulian
Village, Fenggang Town, Dongguan City
Intertek Report No: 201015064GZU-001

Test standards

EN 61000-6-1:2007/ IEC 61000-6-1:2005

EN 61000-6-3:2007+A1:2011/IEC 61000-6-3:2006+A1:2010

Sample Description

Product : Hybrid inverter
Model No. : HYD 6000-EP, HYD 5500-EP, HYD 5000-EP, HYD 4600-EP,
HYD 4000-EP, HYD 3680-EP, HYD 3000-EP
Electrical Rating : See page 6 to 7
Serial No. : Not Labeled
Date Received : 15 October 2020
Date Test : 16 October 2020-27 January 2021
Conducted

Prepared and Checked By

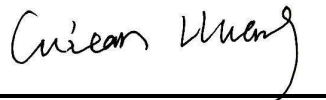

Guitar Huang

Project Engineer

Approved By:



Strong Yao

Manager

This report is for the exclusive use of Intertek's Client and is provided pursuant to the agreement between Intertek and its Client. Intertek's responsibility and liability are limited to the terms and conditions of the agreement. Intertek assumes no liability to any party, other than to the Client in accordance with the agreement, for any loss, expense or damage occasioned by the use of this report. Only the Client is authorized to permit copying or distribution of this report and then only in its entirety. Any use of the Intertek name or one of its marks for the sale or advertisement of the tested material, product or service must first be approved in writing by Intertek. The observations and test results in this report are relevant only to the sample tested. This report by itself does not imply that the material, product, or service is or has ever been under an Intertek certification program.

Intertek Testing Services Shenzhen Ltd. Guangzhou Branch

Room 02, & 101/E201/E301/E401/E501/E601/E701/E801 of Room 01 1-8/F., No. 7-2. Caipin Road, Science City,
GETDD, Guangzhou, Guangdong, China

TEST REPORT

CONTENT

CONTENT	3
1. TEST RESULTS SUMMARY	4
2. EMC RESULTS CONCLUSION	5
3. LABORATORY MEASUREMENTS	8
4. EQUIPMENT USED DURING TEST	9
5. EMI TEST	12
5.1 EN 61000-6-3 CONTINUOUS CONDUCTED DISTURBANCE VOLTAGE TEST	12
5.1.1 <i>Block Diagram of Test Setup</i>	12
5.1.2 <i>Test Setup and Procedure</i>	12
5.1.3 <i>Test Data and curve</i>	13
5.2 EN 61000-6-3 DISCONTINUOUS CONDUCTED DISTURBANCE VOLTAGE	15
5.3 EN 61000-6-3 EMISSION AT TELECOMMUNICATIONS/NETWORK PORTS	15
5.4 EN 61000-6-3 RADIATED EMISSION BELOW 1 GHz.....	16
5.4.1 <i>Block Diagram of Test Setup</i>	16
5.4.2 <i>Test Setup and Procedure</i>	16
5.4.3 <i>Test Data and Curve</i>	17
5.5 EN 61000-6-3 RADIATED EMISSION ABOVE 1 GHz.....	19
6. HARMONICS OF CURRENT	20
6.1 BLOCK DIAGRAM OF TEST SETUP	20
6.2 TEST SETUP AND PROCEDURE.....	20
6.3 TEST DATA.....	20
7. FLICKER	25
7.1 BLOCK DIAGRAM OF TEST SETUP	25
7.2 TEST SETUP AND PROCEDURE.....	25
7.3 TEST DATA.....	26
8. EMS TEST	28
8.1 EN 61000-4-2(PURSUANT TO EN 61000-6-1) ELECTROSTATIC DISCHARGE IMMUNITY	28
8.2 EN 61000-4-6(PURSUANT TO EN 61000-6-1) INJECTED CURRENT (0.15 MHz TO 80 MHz) 31	
8.3 EN 61000-4-4(PURSUANT TO EN 61000-6-1) ELECTRICAL FAST TRANSIENT/BURST.....	32
8.4 EN 61000-4-5(PURSUANT TO EN 61000-6-1) SURGE IMMUNITY	33
8.5 EN 61000-4-11(PURSUANT TO EN 61000-6-1) VOLTAGE DIPS AND INTERRUPTIONS	34
8.6 EN 61000-4-3(PURSUANT TO EN 61000-6-1) RADIATED ELECTROMAGNETIC FIELD IMMUNITY	35
8.7 EN 61000-4-8(PURSUANT TO EN 61000-6-1) POWER FREQUENCY MAGNETIC FIELD	
IMMUNITY.....	38
9. APPENDIX I - PHOTOS OF TEST SETUP	40
10. APPENDIX II – PHOTOS OF EUT	44

TEST REPORT

1. TEST RESULTS SUMMARY

Test Item	Standard	Result
Continuous conducted disturbance voltage	EN 61000-6-3:2007+A1:2011 Reference: EN 55016-2-1:2009	Pass
Discontinuous conducted disturbance voltage	EN 61000-6-3:2007+A1:2011 Reference: EN 55014-1:2006+A1:2009	N/A
Emission at Telecommunications / network Ports	EN 61000-6-3:2007+A1:2011 Reference: EN 55022:2010	N/A
Radiated emission (30 MHz–1000 MHz)	EN 61000-6-3:2007+A1:2011 Reference: EN 55016-2-3:2010	Pass
Radiated emission (1 GHz–6 GHz)	EN 61000-6-3:2007+A1:2011 Reference: EN 55016-2-3:2010	N/A
Harmonic of current	EN 61000-6-3:2007+A1:2011 Reference: EN 61000-3-2 :2014	Pass
Harmonic of current	EN 61000-6-3:2007+A1:2011 Reference: EN 61000-3-12 :2011	Pass
Flicker	EN 61000-6-3:2007+A1:2011 Reference: EN 61000-3-3:2013	Pass
Flicker	EN 61000-6-3:2007+A1:2011 Reference: EN 61000-3-11:2000	Pass
ESD immunity	EN 61000-6-1:2007 Reference: EN 61000-4-2:2009	Pass
Radiated EM field immunity	EN 61000-6-1:2007 Reference: EN 61000-4-3:2006 +A1:2008 + A2:2010	Pass
EFT immunity	EN 61000-6-1:2007 Reference: EN 61000-4-4:2012	Pass
Surge immunity	EN 61000-6-1:2007 Reference: EN 61000-4-5:2006	Pass
Inject current immunity	EN 61000-6-1:2007 Reference: EN 61000-4-6:2009	Pass
Power frequency magnetic field immunity	EN 61000-6-1:2007 Reference: EN 61000-4-8:2010	Pass
Voltage dips and interruption immunity	EN 61000-6-1:2007 Reference: EN 61000-4-11:2004	N/A

Remark:

1. The symbol "N/A" in above table means Not Applicable.
2. When determining the test results, measurement uncertainty of tests has been considered.

TEST REPORT

2. EMC RESULTS CONCLUSION

RE: EMC Testing Pursuant to EMC Directive 2014/30/EU performed on the Hybrid inverter, Model: HYD 6000-EP, HYD 5500-EP, HYD 5000-EP, HYD 4600-EP, HYD 4000-EP, HYD 3680-EP, HYD 3000-EP

The unit is a single-phase hybrid inverter, it can convert the high PV voltage and Grid voltage to low DC for charge battery, also converts PV voltage and battery voltage to AC Grid. The unit is providing EMI filtering at the PV and battery side. It does provide galvanic separation from PV side to Grid. The battery circuit does provide high frequency isolation to PV side and AC mains.

The unit has two controllers. the master DSP controller monitor the charge or discharge statue; measure the PV voltage and current, battery current, bus voltage, AC voltage, current, GFCI and frequency.

The slave DSP controller monitor AC voltage, current ,frequency , GFCI and communicate with the master controller

The master DSP and slave DSP are used together to control relay open or close, if the single fault on one DSP, the other one DSP can be capable to open the relay, so that still providing safety means

Model differences:

The models HYD 6000-EP, HYD 5500-EP, HYD 5000-EP, HYD 4600-EP, HYD 4000-EP, HYD 3680-EP, HYD 3000-EP are identical and only the output power derating in software. except for the following table.

Model	HYD 6000-EP	HYD 5500-EP	HYD 5000-EP	HYD 4600-EP	HYD 4000-EP	HYD 3680-EP	HYD 3000-EP
R332, R334,R336	0Ω, NC, 0Ω				NC, 0Ω, NC		
Bus capacitance	8pcs				6pcs		
INV inductor	0.75mH				1.035mH		
R123,R132	1.5KΩ, 1.5KΩ				499Ω, 499Ω		

The product was tested on:

The Software version: V02000

The Hardware version: V001

We tested the Hybrid inverter, **representative Model HYD 6000-EP with all test and only performed the model HYD 3000-EP with Harmonic of current flicker** to determine if they were in compliance with the relevant EN standards as marked on the Test Results Summary. We found that the unit met the requirement of EN 61000-6-3, EN 61000-6-1 (EN 61000-4-2), EN 61000-6-1 (EN 61000-4-3), EN 61000-6-1 (EN 61000-4-4), EN 61000-6-1 (EN 61000-4-5), EN 61000-6-1 (EN 61000-4-6), EN 61000-6-1(EN 61000-4-8) standards when tested as received. The worst case's test data was presented in this test report.

The production units are required to conform to the initial sample as received when the units are placed on the market.

TEST REPORT

Model	HYD 3000- EP	HYD 3680-EP	HYD 4000-EP	HYD 4600-EP	HYD 5000-EP	HYD 5500-EP	HYD 6000-EP
Max. PV Input Voltage [d.c.V]	600						
MPPT operating voltage range [d.c.V]	90-580						
Number of MPP trackers	2						
Max. input current per MPPT [d.c.A]	13/13						
Max. PV Isc [d.c.A]	2 X 18						
Battery Type	Lead-acid, Lithium-ion						
Battery Voltage Range [d.c.V]	42-58						
Max. Charging Current [d.c.A]	75	80	85	100	100	100	100
Max. Discharging Current [d.c.A]	75	80	85	100	100	100	100
Max. Charging & Discharging Power [W]	3750	4000	4250	5000	5000	5000	5000
Nominal Grid voltage [a.c.V]	230						
Nominal Output Voltage (backup) [a.c.V]	230						
Max. output current [a.c.A]	15	16	20	20.9	21.7	25	27.3
Max AC current from utility grid [a.c.A]	27.3	32	36.4	41.8	43.4	43.4	54.6
Nominal Grid Frequency	50/60Hz						

TEST REPORT

Power Factor	1 (adjustable +/-0.8)						
Nominal AC power [W]	3000	3680	4000	4600	5000	5000	6000
Backup Max.current [a.c.A]	13.6	16.0	18.2	20.9	22.7	22.7	22.7
Backup Max. Apparent Power [VA]	3000	3680	4000	4600	5000	5000	5000
Ingress Protection	IP 65						
Protective Class	Class I						
Operating temperature range	-30 ~ +60°C						

TEST REPORT

3. LABORATORY MEASUREMENTS

Configuration Information

Support Equipment: N/A

Rated Voltage and frequency under test: See page 6 to 7

Condition of Environment: Temperature: 22~28°C
Relative Humidity:35~60%
Atmosphere Pressure:86~106kPa

Notes:

- The EMI measurements had been made in the operating mode produced the largest emission in the frequency band being investigated consistent with normal applications. An attempt had been made to maximize the emission by varying the configuration of the EUT.
- The EMS measurements had been made in the frequency bands being investigated, with the EUT in the most susceptible operating mode consistent with normal applications. The configuration of the test sample had been varied to achieve maximum susceptibility.
- Test Location:
All tests were performed at:
Shenzhen EMTEK Co.,Ltd.
Bldg. 69, Majialong Industry Zone, Nanshan District, Shenzhen,Guangdong,China.

4.Measurement Uncertainty

No.	Item	Measurement Uncertainty
1	Conduction Emission (9 kHz-150 kHz)	2.96 dB
2	Conduction Emission (150 kHz-30 MHz)	2.74dB
3	Disturbance Power (30 MHz-300 MHz)	2.53dB
4	Radiated Emission (30 MHz-1 GHz)	H: 3.96dB; V: 4.04dB
5	Radiated Emission (1 GHz-6 GHz)	4.46dB
6	Radiated Emission (6 GHz-18 GHz)	4.96dB

The measurement uncertainty describes the overall uncertainty of the given measured value during the operation of the EUT.
Measurement uncertainty is calculated in accordance with CISPR16-4-2:2011
The measurement uncertainty is given with a confidence of 95%, k=2.

TEST REPORT

4. EQUIPMENT USED DURING TEST

Conducted Disturbance-Mains Terminal				
Equipment No.	Equipment	Model	Manufacturer	Calibration Interval
EE020	Test Receiver	ESCS30	Rohde & Schwarz	1Y
EE156	L.I.S.N.	NNLK8129	Schwarzbeck	1Y
EE020-3	50Ω Coaxial Switch	MP59B	Anritsu	1Y
EE020-1	Pulse Limiter	ESH3-Z2	Rohde & Schwarz	1Y
Radiated Emission below 1 GHz				
Equipment No.	Equipment	Model	Manufacturer	Calibration Interval
EE226	EMI Test Receiver	ESR3	Rohde & Schwarz	1Y
EE249	EMI Test Receiver	ESR3	Rohde & Schwarz	1Y
EE264	Pre-Amplifier	LNA 10M1G-40	Lunar EM	1Y
EE263	Pre-Amplifier	LNA 10M1G-40	Lunar EM	1Y
EE231	Bilog Antenna	VULB9163	Schwarzbeck	1Y
EE246	Bilog Antenna	VULB9163	Schwarzbeck	1Y
EE318	Cable	LMR-240 N-N 1m	Times Microwave	1Y
EE319	Cable	LMR-240 N-N 1m	Times Microwave	1Y
EE320	Cable	LMR-240 N-N 1.5m	Times Microwave	1Y
EE321	Cable	LMR-240 N-N 1.5m	Times Microwave	1Y
EE323	Cable	LMR-240 N-N 12m	Times Microwave	1Y
EE322	Cable	LMR-240 N-N 11m	Times Microwave	1Y

TEST REPORT

Harmonic Currents and Flicker(1)

Equipment No.	Equipment	Model	Manufacturer	Calibration Interval
EE206	45KVA AC Power source	NSG 1007-45/45KVA	Teseq	1Y
EE206-1	Signal conditioning Unit	CCN 1000-3	Teseq	1Y
EE206-2	Three phase impedance network	INA2197/37A	Teseq/Germany	1Y
EE206-3	Three phase impedance network	INA 2196/75A	Teseq/Germany	1Y
EE207	Proflin 2100 AC Switching Unit	NSG2200-3	Teseq/Germany	1Y

Electrostatic Discharge (1)

Equipment No.	Equipment	Model	Manufacturer	Calibration Interval
EM077-04	ESD Simulator	NSG437	TESEQ	1Y
SA047-143	Digital Temperature-Humidity Recorder	AW5145Y	ASAIR	1Y

Radiated Electromagnetic Field Immunity				
Equipment No.	Equipment	Model	Manufacturer	Calibration Interval
EE218	Signal Generator	N5181A	Agilent	1Y
EE066-6	RF Power Meter. Dual Channel	4232A	BOONTON	1Y
EE066-4	50ohm Diode Power Sensor	51011EMC	BOONTON	1Y
EE221	Field Strength Meter	RSS1006A	DARE	1Y
EE219	50ohm Diode Power Sensor	51011EMC	BOONTON	1Y
EE066-1	Power Amplifier	80RF1000-175	MILMEGA	1Y
EE066-2	Power Amplifier	AS0102-55	MILMEGA	1Y
EE224	Power Amplifier	AS1860-50	MILMEGA	1Y
EE067	Log.-Per. Antenna	VULP 9118E	SCHWARZBECK	1Y
EE220	Broad-Band Horn Antenna	STLP 9149	SCHWARZBECK	1Y
EE222	Multi-function interface system	CTR1009B	DARE	1Y
EE223	Automatic switch group	RSW 1004A	DARE	1Y

TEST REPORT

Electrical Fast Transient/Burst				
Equipment No.	Equipment	Model	Manufacturer	Calibration Interval
EE014	Burst Tester	PEFT4010	HAEFELY	1Y
EE015	Coupling Clamp	IP-4A	HAEFELY	1Y
EE205	Three phase CDN	CDN 163	Teseq	1Y

Surge				
Equipment No.	Equipment	Model	Manufacturer	Calibration Interval
EE162	Surge Controller	Psurge 8000	HAEFELY	1Y
EE162-1	Impulse Module	PIM 100	HAEFELY	1Y
EE162-2	Coupling Decoupling Filter	PCD 130	HAEFELY	1Y
EE162-3	Coupling Module	PCD122	HAEFELY	1Y
EE162-4	Surge Impulse Module	PIM 120	HAEFELY	1Y
EE162-5	Coupling Module	PCD 126A	HAEFELY	1Y
EE162-6	Impulse Module	PIM 110	HAEFELY	1Y
EE162-7	Impulse Module	PIM 150	HAEFELY	1Y

Conducted Susceptibility

Equipment No.	Equipment	Model	Manufacturer	Calibration Interval
EE-007-1	Continuous Wave Simulator	CWS500C	EMTEST	1Y
EE-007-4	EM Injection Clamp	F-2031-23MM	EMTEST	1Y
EE-204-1	Three phase CDN	CDN M432S	TESEQ	1Y

Power Frequency Magnetic Field Immunity				
Equipment No.	Equipment	Model	Manufacturer	Calibration Interval
EE006	Magnetic Field Tester	MAG100	HAEFELY	1Y

TEST REPORT

5. EMI TEST

5.1 EN 61000-6-3 Continuous Conducted Disturbance Voltage Test

Test Result: Pass

5.1.1 Block Diagram of Test Setup

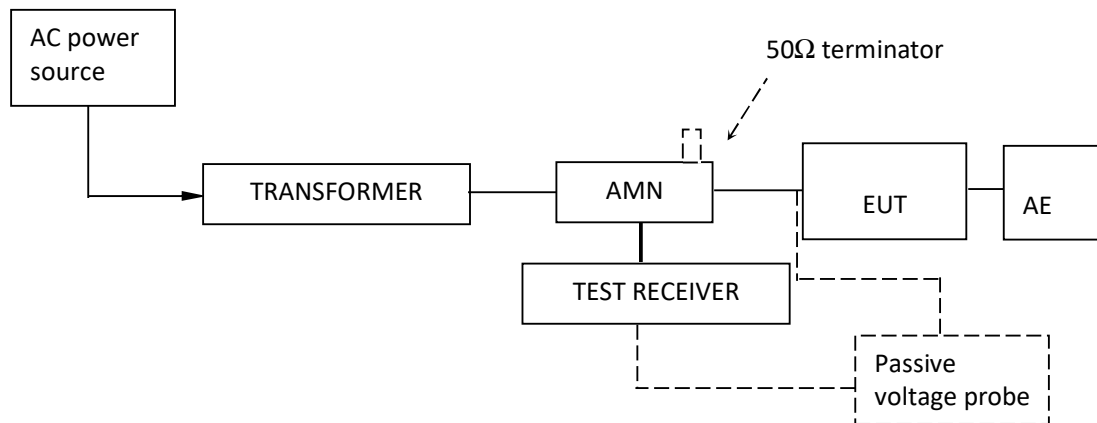

5.1.2 Test Setup and Procedure

The EUT was set to achieve the maximum emission level. The mains terminal disturbance voltage was measured with the EUT in a shielded room. The EUT was connected to AC power source through an Artificial Mains Network which provides a 50Ω linear impedance artificial hand is used if appropriate (for handheld apparatus). The load/control terminal disturbance voltage was measured with passive voltage probe if appropriate.

The table-top EUT was placed on a 0.8m high non-metallic table above earthed ground plane (Ground Reference Plane). And for floor standing EUT, was placed on a 0.1m high non-metallic supported on GRP. The EUT keeps a distance of at least 0.4m from a vertical metallic surface. The Artificial Mains Network is situated at a distance of 0.8m from the EUT.

During the test, mains lead of EUT excess 0.8m was folded back and forth parallel to the lead so as to form a horizontal bundle with a length between 0.3m and 0.4m.

The bandwidth of test receiver was set at 9 kHz. The frequency range from 150 kHz to 30 MHz was checked.

TEST REPORT

5.1.3 Test Data and curve

At mains terminal:

Tested Wire: Live 1

Operation Mode: inverting mode with full load

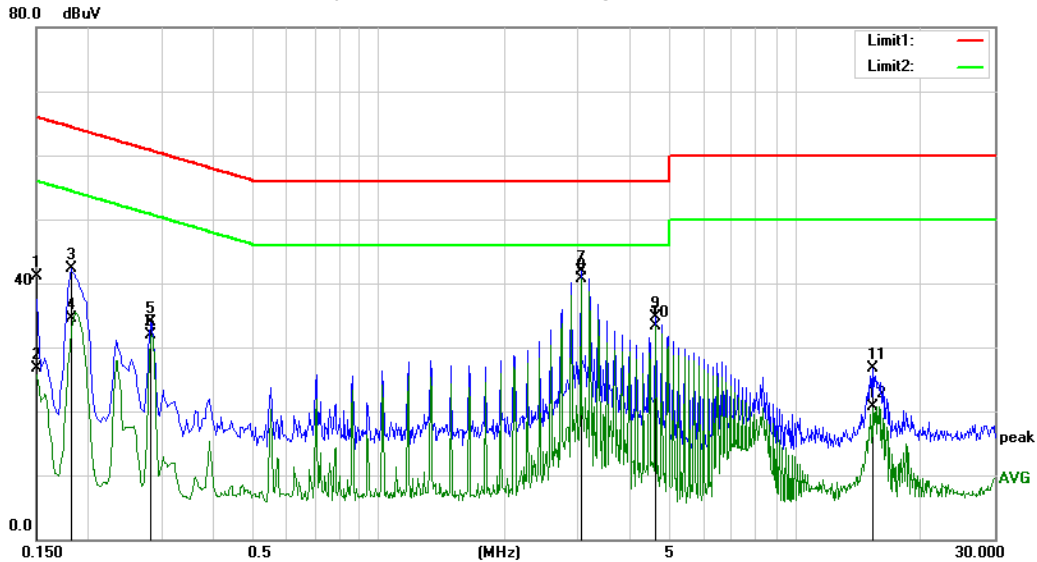

No. Mk.	Freq. MHz	Reading Level dBuV	Correct Factor dB	Measurement dBuV	Limit dBuV	Over dB	Detector
1	0.1500	30.46	10.65	41.11	66.00	-24.89	QP
2	0.1500	15.96	10.65	26.61	56.00	-29.39	AVG
3	0.1820	31.72	10.49	42.21	64.39	-22.18	QP
4	0.1820	23.94	10.49	34.43	54.39	-19.96	AVG
5	0.2820	23.58	10.39	33.97	60.76	-26.79	QP
6	0.2820	21.57	10.39	31.96	50.76	-18.80	AVG
7	3.0500	31.63	10.25	41.88	56.00	-14.12	QP
8 *	3.0500	30.48	10.25	40.73	46.00	-5.27	AVG
9	4.6100	24.31	10.30	34.61	56.00	-21.39	QP
10	4.6100	22.95	10.30	33.25	46.00	-12.75	AVG
11	15.2380	16.48	10.29	26.77	60.00	-33.23	QP
12	15.2380	10.44	10.29	20.73	50.00	-29.27	AVG

Remark:

1. Corr. (dB) = LISN Factor (dB) + Cable Loss (dB)
2. Level (dBμV) = Corr. (dB) + Read Level (dBμV)
3. Delta Limit (dB) = Level (dBμV)-Limit (dBμV)

TEST REPORT

Tested Wire: Neutral

Operation Mode: inverting mode with full load

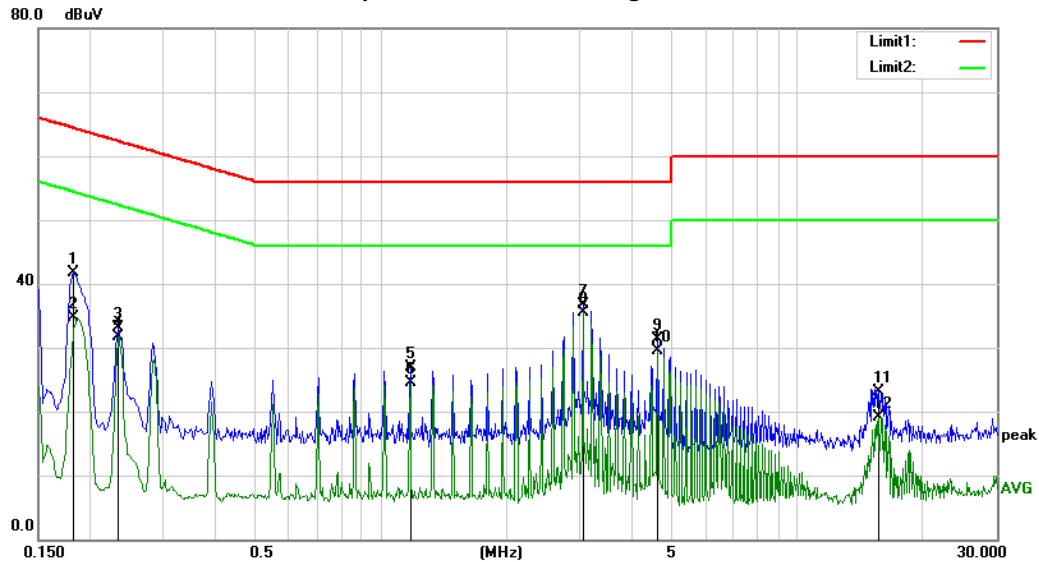

No.	Mk.	Freq. MHz	Reading Level dBuV	Correct Factor dB	Measure- ment dBuV	Limit dBuV	Over dB	Detector
1		0.1825	31.29	10.49	41.78	64.37	-22.59	QP
2		0.1825	24.23	10.49	34.72	54.37	-19.65	AVG
3		0.2340	22.76	10.40	33.16	62.31	-29.15	QP
4		0.2340	21.29	10.40	31.69	52.31	-20.62	AVG
5		1.1740	16.73	10.23	26.96	56.00	-29.04	QP
6		1.1740	14.30	10.23	24.53	46.00	-21.47	AVG
7		3.0500	26.47	10.25	36.72	56.00	-19.28	QP
8	*	3.0500	25.28	10.25	35.53	46.00	-10.47	AVG
9		4.6100	21.04	10.30	31.34	56.00	-24.66	QP
10		4.6100	19.24	10.30	29.54	46.00	-16.46	AVG
11		15.7060	12.78	10.29	23.07	60.00	-36.93	QP
12		15.7060	8.76	10.29	19.05	50.00	-30.95	AVG

Remark:

1. Corr. (dB) = LISN Factor (dB) + Cable Loss (dB)
2. Level (dBμV) = Corr. (dB) + Read Level (dBμV)
3. Delta Limit (dB) = Level (dBμV)-Limit (dBμV)

TEST REPORT

5.2 EN 61000-6-3 Discontinuous Conducted Disturbance Voltage

Test Result: Not applicable

5.3 EN 61000-6-3 Emission at Telecommunications/network Ports

Test Result: Not Applicable

Remark: The test only apply to balanced telecommunication ports intended for connection to unscreened balanced pairs

TEST REPORT

5.4 EN 61000-6-3 Radiated Emission below 1 GHz

Test Result: Pass

5.4.1 Block Diagram of Test Setup

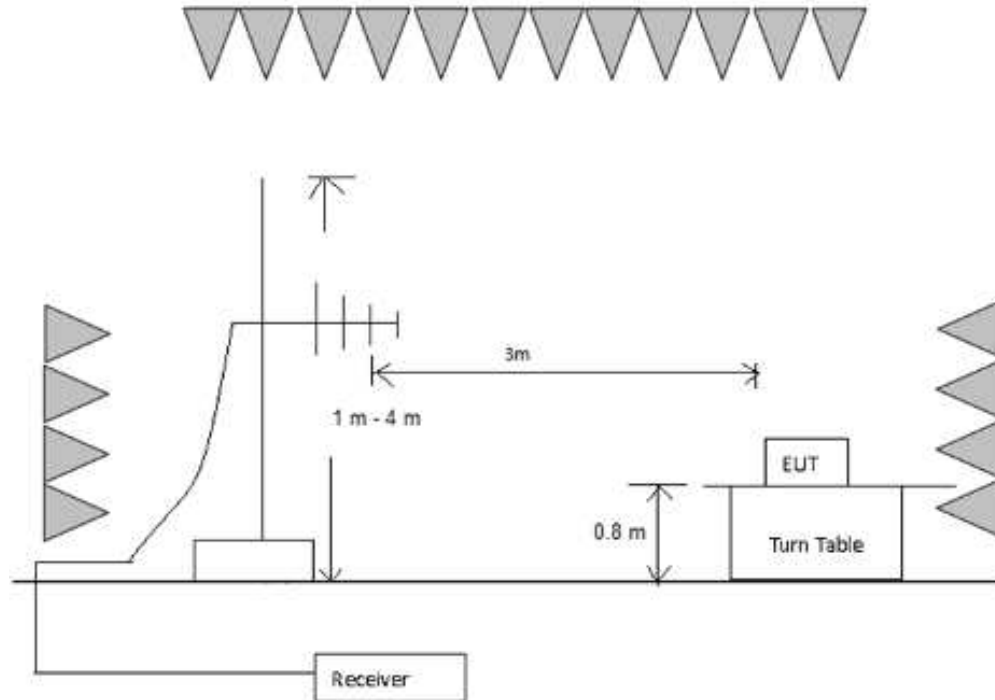

5.4.2 Test Setup and Procedure

The measurement was applied in a semi-anechoic chamber. The EUT and simulators were placed on a 0.8m high wooden turntable above the horizontal metal ground plane. The turn table rotated 360 degrees to determine the position of the maximum emission level. The EUT was set 10 meters away from the receiving antenna which was mounted on an antenna mask. The antenna moved up and down between from 1meter to 4 meters to find out the maximum emission level.

Broadband antenna was used as receiving antenna. Both horizontal and vertical polarization of the antenna was set on measurement. In order to find the maximum emission, all of the interface cables were manipulated according to EN55032 requirement during radiated test. The bandwidth setting on R&S Test Receiver was 120 kHz. The frequency range from 30MHz to 1000MHz was checked

TEST REPORT

5.4.3 Test Data and Curve

Operation Mode: inverting mode with full load

Horizontal

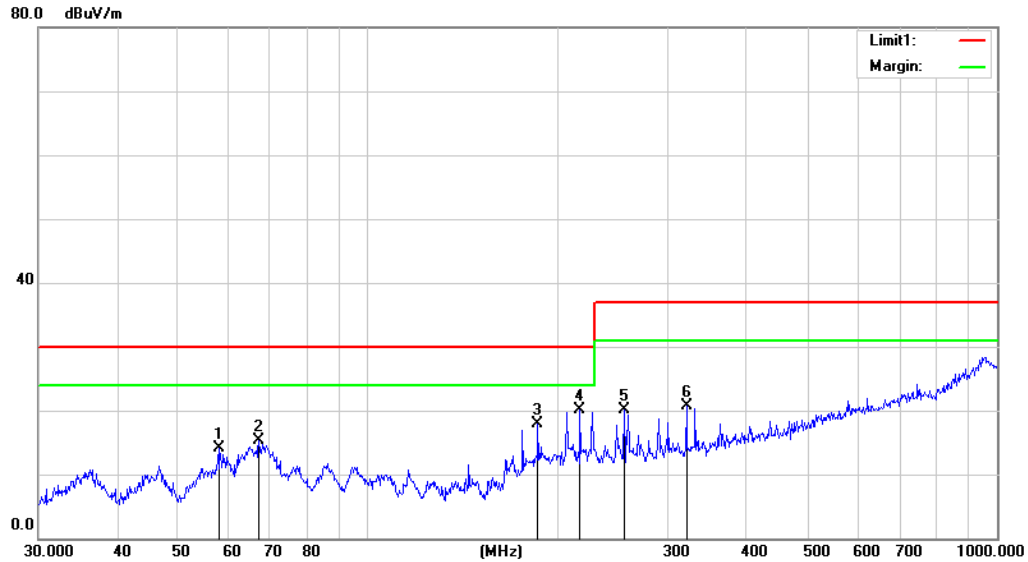

No.	Mk.	Freq. MHz	Reading Level dBuV	Ant. Factor dB/m	Pre Amp Gain dB	Cable loss dB	Measure- ment dBuV/m	Limit dBuV/m	Over dB	Detector
1		57.9993	44.56	11.82	43.53	1.26	14.11	30.00	-15.89	QP
2		67.2022	47.52	10.06	43.56	1.34	15.36	30.00	-14.64	QP
3		186.4410	48.93	10.64	43.96	2.27	17.88	30.00	-12.12	QP
4	*	217.5443	49.47	11.86	43.76	2.51	20.08	30.00	-9.92	QP
5		255.6231	47.81	12.78	43.22	2.78	20.15	37.00	-16.85	QP
6		321.0608	46.08	13.82	42.4	3.24	20.74	37.00	-16.26	QP

Remark:

1. Corr. (dB) = Antenna Factor (dB) + Cable Loss (dB)
2. Quasi Peak (dBμV/m) = Corr. (dB) + Read Level (dBμV)
3. Margin (dB) = Limit QPK (dBμV/m) – Quasi Peak (dBμV/m)

TEST REPORT

Vertical

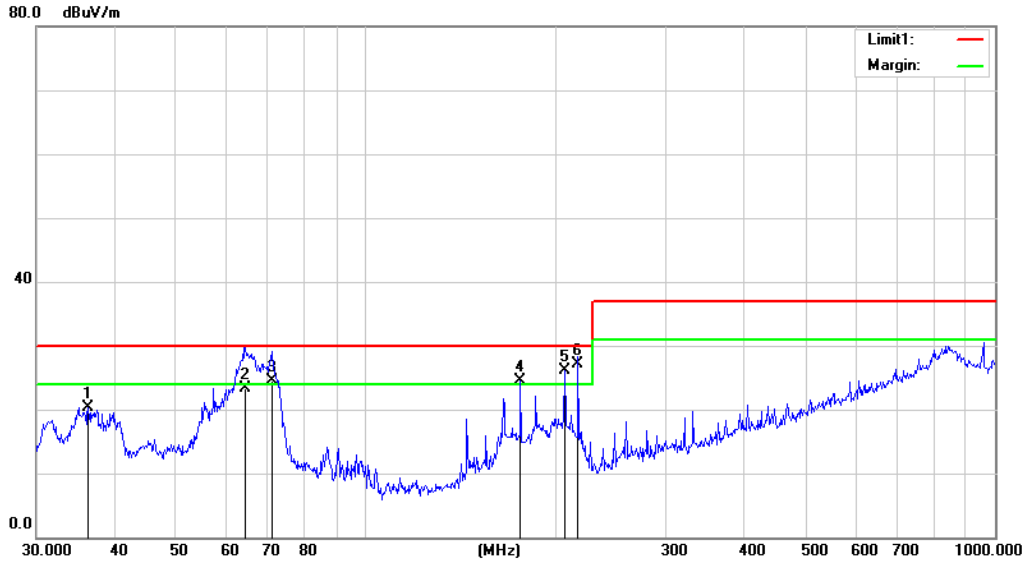

No.	Mk.	Freq. MHz	Reading Level dBuV	Ant. Factor dB/m	Pre Amp Gain dB	Cable loss dB	Measure- ment dBuV/m	Limit dBuV/m	Over dB	Detector
1		36.2541	50.92	11.3	43.28	1.39	20.33	30.00	-9.67	QP
2		64.4331	52.51	12.42	43.35	1.82	23.40	30.00	-6.60	QP
3	!	71.0803	55.00	11.06	43.36	1.9	24.60	30.00	-5.40	QP
4	!	176.2686	55.14	9.69	43.51	3.12	24.44	30.00	-5.56	QP
5	!	207.1226	56.31	9.87	43.49	3.37	26.06	30.00	-3.94	QP
6	*	217.5443	56.88	10.27	43.43	3.48	27.20	30.00	-2.80	QP

Remark:

1. Corr. (dB) = Antenna Factor (dB) + Cable Loss (dB)
2. Quasi Peak (dBμV/m) = Corr. (dB) + Read Level (dBμV)
3. Margin (dB) = Limit QPK (dBμV/m) –Quasi Peak (dBμV/m)

TEST REPORT

5.5 EN 61000-6-3 Radiated Emission above 1 GHz

Test Result: Not Applicable

Remark:

The highest internal source of the EUT is not more than 108 MHz, so the measurement above 1000 MHz is not applicable.

TEST REPORT

6. Harmonics of current

Test Result: Pass

6.1 Block Diagram of Test Setup

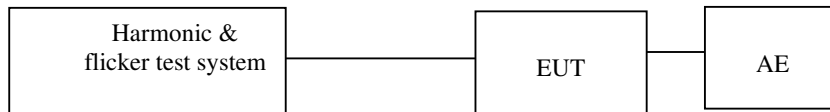

6.2 Test Setup and Procedure

Harmonics of the fundamental current were measured up to 40 order harmonics using a digital power meter with an analogue output and frequency analyzer which was integrated in the harmonic & flicker test system. The measurements were carried out under steady conditions.

6.3 Test Data

TEST REPORT

Model: HYD 6000-EP

Operation Mode: inverting mode with full load

Harmonics – Per EN/IEC61000-3-12, Ed. 2.0(Run time)

Test Result: Pass

Source qualification: Normal

Current & voltage waveforms

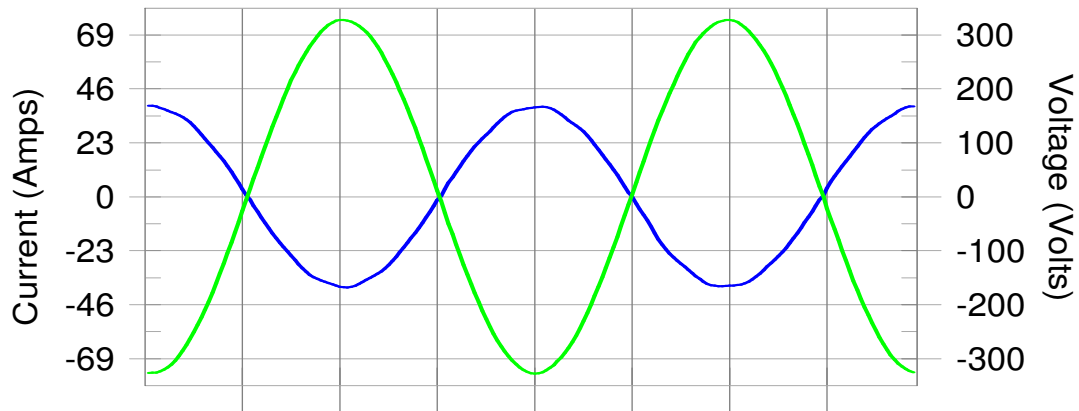

Harmonics and Class 2 limit line

European Limits

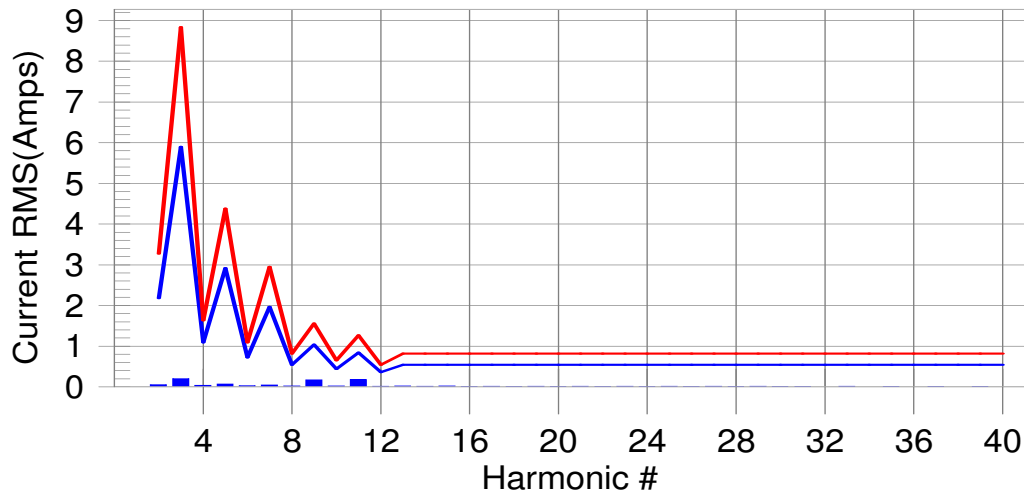

Test result: Pass Worst harmonics H11-14.2% of 150% limit, H11-21.2% of 100% limit.

TEST REPORT

Current Test Result Summary (Run time)

Test Result: Pass Measured Iref: 27.280(Amps) Source: Normal
 THC/Iref (%): 0.0 Limit (%): 23.0 PWHC/Iref (%): 0.0 PWHC Limit (%): 23.0

Highest parameter values during test:

V_RMS (Volts):	231.37	Frequency (Hz):	50.00
I_Peak (Amps):	39.038	I_RMS (Amps):	27.307
I_Fund (Amps):	27.273(avg)	Crest Factor:	1.431
Power (Watts):	-6307	Power Factor:	-0.998

Harm#	Harms(avg)	100%Limit	%of Limit	Harms(max)	150%Limit	%of Limit	Status
2	0.061	2.182	2.8	0.067	3.274	2.0	Pass
3	0.207	5.893	3.5	0.219	8.839	2.5	Pass
4	0.045	1.091	4.2	0.049	1.637	3.0	Pass
5	0.072	2.919	2.5	0.074	4.378	1.7	Pass
6	0.033	0.727	4.5	0.036	1.091	3.3	Pass
7	0.051	1.964	2.6	0.055	2.946	1.9	Pass
8	0.027	0.546	5.0	0.031	0.818	3.8	Pass
9	0.178	1.037	17.2	0.180	1.555	11.6	Pass
10	0.022	0.436	5.1	0.025	0.655	3.9	Pass
11	0.179	0.846	21.2	0.181	1.269	14.2	Pass
12	0.018	0.364	5.0	0.021	0.546	3.8	Pass
13	0.024	0.546	4.3	0.030	0.818	3.7	Pass
14	0.015	N/A	N/A	0.018	N/A	N/A	N/A
15	0.025	N/A	N/A	0.030	N/A	N/A	N/A
16	0.011	N/A	N/A	0.013	N/A	N/A	N/A
17	0.017	N/A	N/A	0.023	N/A	N/A	N/A
18	0.009	N/A	N/A	0.013	N/A	N/A	N/A
19	0.016	N/A	N/A	0.022	N/A	N/A	N/A
20	0.009	N/A	N/A	0.011	N/A	N/A	N/A
21	0.015	N/A	N/A	0.021	N/A	N/A	N/A
22	0.008	N/A	N/A	0.010	N/A	N/A	N/A
23	0.016	N/A	N/A	0.021	N/A	N/A	N/A
24	0.007	N/A	N/A	0.009	N/A	N/A	N/A
25	0.015	N/A	N/A	0.020	N/A	N/A	N/A
26	0.008	N/A	N/A	0.009	N/A	N/A	N/A
27	0.016	N/A	N/A	0.023	N/A	N/A	N/A
28	0.009	N/A	N/A	0.011	N/A	N/A	N/A
29	0.015	N/A	N/A	0.019	N/A	N/A	N/A
30	0.007	N/A	N/A	0.009	N/A	N/A	N/A
31	0.013	N/A	N/A	0.017	N/A	N/A	N/A
32	0.005	N/A	N/A	0.006	N/A	N/A	N/A
33	0.014	N/A	N/A	0.019	N/A	N/A	N/A
34	0.005	N/A	N/A	0.006	N/A	N/A	N/A
35	0.012	N/A	N/A	0.016	N/A	N/A	N/A
36	0.004	N/A	N/A	0.006	N/A	N/A	N/A
37	0.011	N/A	N/A	0.015	N/A	N/A	N/A
38	0.004	N/A	N/A	0.005	N/A	N/A	N/A
39	0.011	N/A	N/A	0.014	N/A	N/A	N/A
40	0.003	N/A	N/A	0.004	N/A	N/A	N/A

Note: Measured I-ref was applied for this test.

TEST REPORT

Model: HYD 3000-EP

Operation Mode: inverting mode with full load

Harmonics – Class-A per Ed. 5.0 (2018)(Run time) incl. inter-harmonics

Test Result: Pass Source qualification: Normal

Current & voltage waveforms

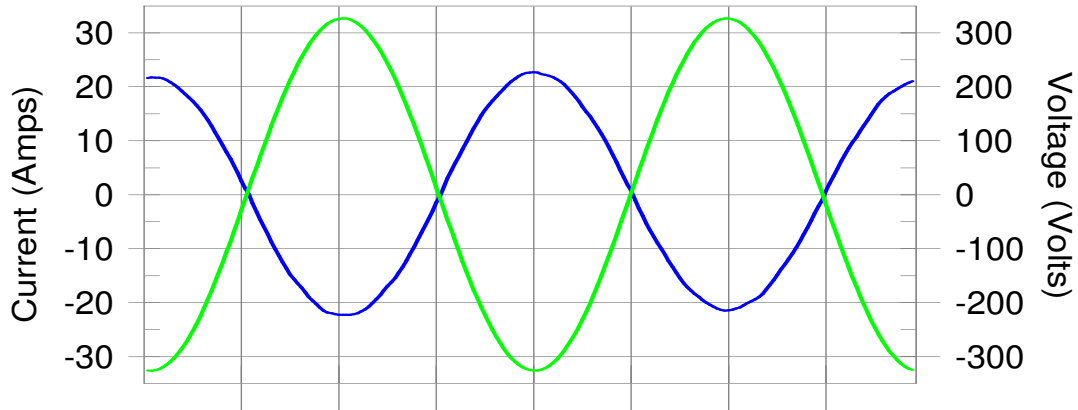

Harmonics and Class A limit line

European Limits

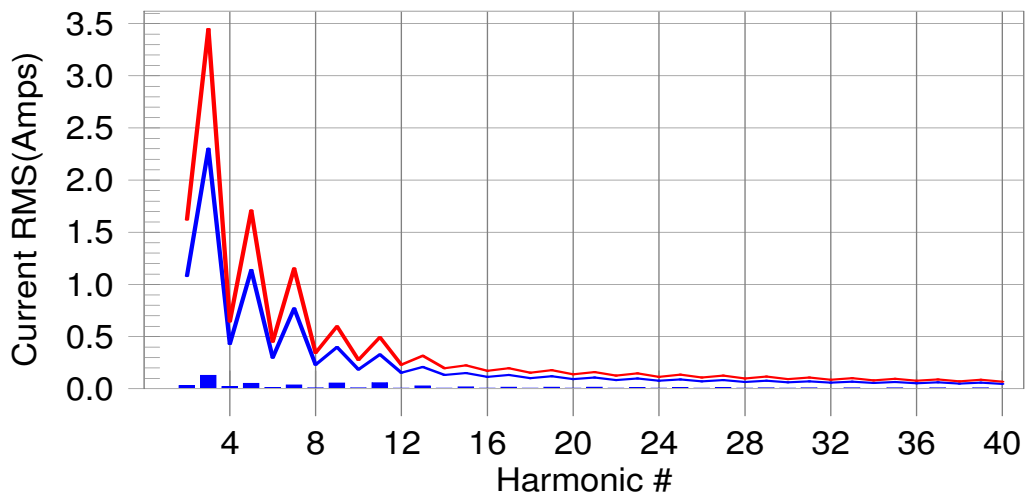

Test result: Pass Worst harmonics H27-14.3% of 150% limit, H11-17.4% of 100% limit.

TEST REPORT

Current Test Result Summary (Run time)

Test Result: Pass Source qualification: Normal
 THC(A): 0.181 I-THD(%): 1.2 POHC(A): 0.038 POHC Limit(A): 0.251

Highest parameter values during test:

V_RMS (Volts):	230.800	Frequency(Hz):	50.00
I_Peak (Amps):	22.859	I_RMS (Amps):	14.954
I_Fund (Amps):	14.472	Crest Factor:	2.756
Power (Watts):	-3338.1	Power Factor:	-0.999

Harm#	Harms(avg)	100%Limit	%of Limit	Harms(max)	150%Limit	%of Limit	Status
2	0.033	1.080	3.0	0.094	1.620	5.8	Pass
3	0.128	2.300	5.6	0.163	3.450	4.7	Pass
4	0.022	0.430	5.0	0.059	0.645	9.2	Pass
5	0.052	1.140	4.6	0.075	1.710	4.4	Pass
6	0.012	0.300	4.1	0.039	0.450	8.6	Pass
7	0.038	0.770	4.9	0.053	1.155	4.6	Pass
8	0.010	0.230	4.5	0.030	0.345	8.7	Pass
9	0.057	0.400	14.1	0.060	0.600	10.1	Pass
10	0.009	0.184	4.9	0.025	0.276	9.1	Pass
11	0.057	0.330	17.4	0.061	0.495	12.3	Pass
12	0.008	0.153	N/A	0.020	0.230	N/A	Pass
13	0.030	0.210	14.3	0.035	0.315	11.1	Pass
14	0.007	0.131	N/A	0.019	0.197	N/A	Pass
15	0.019	0.150	12.6	0.026	0.225	11.4	Pass
16	0.006	0.115	N/A	0.017	0.173	N/A	Pass
17	0.017	0.132	13.2	0.023	0.198	11.4	Pass
18	0.006	0.102	N/A	0.015	0.153	N/A	Pass
19	0.016	0.118	13.5	0.020	0.178	11.1	Pass
20	0.006	0.092	N/A	0.014	0.138	N/A	Pass
21	0.015	0.107	14.2	0.020	0.161	12.2	Pass
22	0.007	0.084	N/A	0.013	0.125	N/A	Pass
23	0.014	0.098	14.7	0.019	0.147	12.7	Pass
24	0.008	0.077	N/A	0.014	0.115	N/A	Pass
25	0.014	0.090	15.0	0.018	0.135	13.2	Pass
26	0.008	0.071	N/A	0.015	0.107	N/A	Pass
27	0.013	0.083	15.8	0.018	0.125	14.3	Pass
28	0.007	0.066	N/A	0.013	0.099	N/A	Pass
29	0.011	0.078	14.4	0.015	0.116	12.6	Pass
30	0.005	0.061	N/A	0.010	0.092	N/A	Pass
31	0.011	0.073	14.6	0.014	0.109	13.0	Pass
32	0.004	0.058	N/A	0.010	0.086	N/A	Pass
33	0.011	0.068	15.7	0.013	0.102	12.6	Pass
34	0.004	0.054	N/A	0.009	0.081	N/A	Pass
35	0.009	0.064	14.7	0.012	0.096	12.2	Pass
36	0.004	0.051	N/A	0.008	0.077	N/A	Pass
37	0.009	0.061	15.5	0.012	0.091	13.1	Pass
38	0.004	0.048	N/A	0.008	0.073	N/A	Pass
39	0.009	0.058	16.1	0.012	0.087	13.4	Pass
40	0.003	0.046	N/A	0.006	0.069	N/A	Pass

TEST REPORT

7. Flicker

Test Result: Pass

7.1 Block Diagram of Test Setup

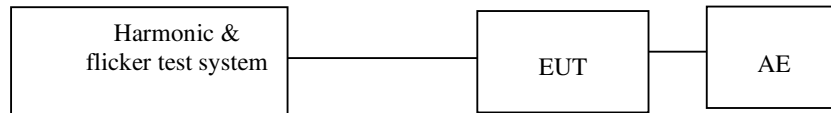

7.2 Test Setup and Procedure

7.2.1 Definition

Flicker:	impression of unsteadiness of visual sensation induced by a lighting stimulus whose luminance or spectral distribution fluctuates with time.
Pst:	Short-term flicker indicator The flicker severity evaluated over a short period (in minutes); Pst=1 is the conventional threshold of irritability
Plt:	long-term flicker indicator; the flicker severity evaluated over a long period (a few hours). Using successive Pst valuse.
dc:	the relative steady-state voltage change
dmax:	the maximum relative voltage change
d(t):	the value during a voltage change

7.2.2 Test condition

The EUT was set to produce the most unfavourable sequence of voltage changes.

TEST REPORT

7.3 Test Data

Model: HYD 6000-EP

Operation Mode: inverting mode with full load

Flicker Test Summary Per EN/IEC61000-3-11, Ed. 1.0(Run time) per EN/IEC61000-3-11 IEC61000-3-11 Ed. 1.0 (2000)

Z-test = (0.400 + j 0.250 Ohm)

Test Result: Pass

Status: Test Completed

Parameter values recorded during the test:

Vrms at the end of test (Volt): 230.01

T-max (mS):	0.0	Test limit (mS):	500.0	Pass
Highest dc (%):	0.00	Test limit (%):	3.30	Pass
Highest dmax (%):	-0.70	Test limit (%):	4.00	Pass
Highest Pst (10 min. period):	0.676	Test limit:	1.000	Pass
Highest Plt (2 hr. period):	0.295	Test limit:	0.650	Pass

TEST REPORT

Model: HYD 3000-EP

Operation Mode: inverting mode with full load

Flicker Test Summary per EN/IEC61000-3-3 Ed. 3.0 (2013) (Run time)

Test Result: Pass

Status: Test Completed

Parameter values recorded during the test:

Vrms at the end of test (Volt):	228.25			
T-max (mS):	0.0	Test limit (mS):	500.0	Pass
Highest dc (%):	0.90	Test limit (%):	3.30	Pass
Highest dmax (%):	1.15	Test limit (%):	4.00	Pass
Highest Pst (10 min. period):	0.315	Test limit:	1.000	Pass
Highest Plt (2 hr. period):	0.138	Test limit:	0.650	Pass

TEST REPORT

8. EMS TEST

Performance Criteria:

- Criterion A: The apparatus shall continue to operate as intended during the test. No degradation of performance or loss of function is allowed below a performance level (or permission loss of performance) specified by the manufacturer, when the apparatus is used as intended. If the minimum performance level or the permissible performance loss is not specified by the manufacturer, then either of these may be derived from the product description and documentation and from what the user may reasonably expect from the apparatus if used as intended.
- Criterion B: The apparatus shall continue to operate as intended after the test. No degradation of performance or loss of function is allowed below a performance level (or permission loss of performance) specified by the manufacturer, when the apparatus is used as intended. During the test, degradation of performance is allowed, however, no change of actual operating state or stored data is allowed. If the minimum performance level or the permissible performance loss is not specified by the manufacturer, then either of these may be derived from the product description, and documentation, and from what the user may reasonably expect from the apparatus if used as intended.
- Criterion C: Temporary loss of function is allowed, provided the function is self-recoverable or can be restored by the operation of the controls, or by any operation specified in the instruction for use.

Operation mode of EMS test:

Test Item	Operation mode
ESD immunity	inverting mode with light load
Radiated EM field immunity	
EFT immunity	
Surge immunity	
Inject current immunity	
Power frequency magnetic field immunity	
Voltage dips and interruption immunity	N/A

Note: "N/A" means Not Applicable in below text.

8.1 EN 61000-4-2(Pursuant to EN 61000-6-1) Electrostatic Discharge Immunity

Performance criterion: B

Test Result: Pass

TEST REPORT

8.1.1 Block Diagram of Test Setup

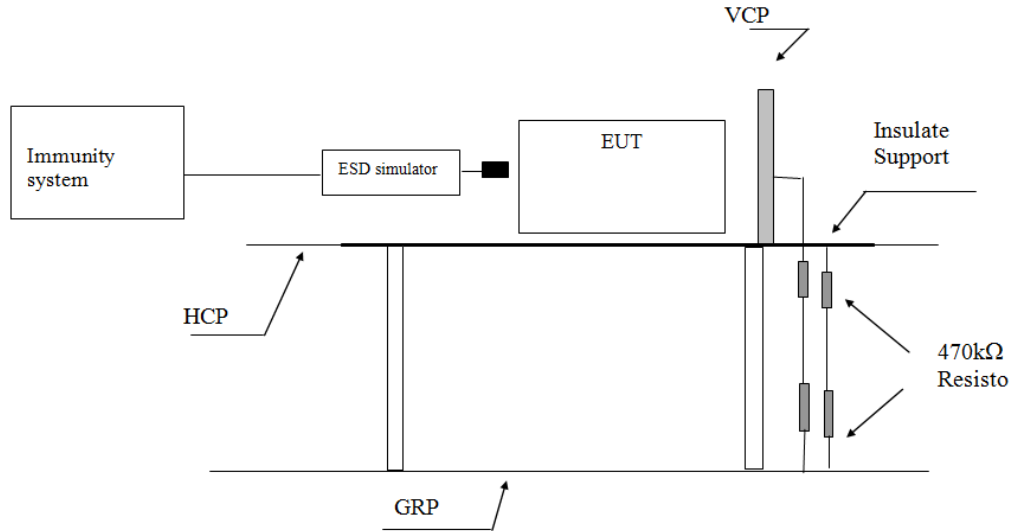

Note: HCP means Horizontal Coupling Plane,

VCP means Vertical Coupling Plane

GRP means Ground Reference Plane

8.1.2 Test Setup and Procedure

The EUT was put on a 0.8m high wooden table 0.1m high for floor standing equipment standing on the ground reference plane (GRP) 3m by 2m in size, made by iron 1.0 mm thick.

A horizontal coupling plane(HCP) 1.6m by 0.8m in size was placed on the table, and the EUT with its cables were isolated from the HCP by an insulating support thick than 0.5mm. The VCP 0.5m by 0.5m in size & HCP were constructed from the same material type & thickness as that of the GRP, and connected to the GRP via a 470kΩ resistor at each end.

The distance between EUT and any of the other metallic surface excepted the GRP, HCP & VCP was greater than 1m.

The EUT was arranged and connected according to its functional requirements.

Direct static electricity discharges were applied only to those points and surface which were accessible to personnel during normal usage.

TEST REPORT

On each preselected points 10 times of each polarity single discharge were applied. The time interval between successive single discharges was at least 1s.

The ESD generator was held perpendicular to the surface to which the discharge was applied. The discharge return cable of the generator was kept at a distance of 0.2m whilst the discharge was being applied. During the contact discharges, the tip of the discharge electrode was touched the EUT before the discharge switch was operated. During the air discharges, the round discharge tip of the discharge electrode was approached as fast as possible to touch the EUT.

Indirect discharge was conducted to objects placed near the EUT, simulated by applying the discharges of the ESD generator to a coupling plane, in the contact discharge mode.

After each discharge, the ESD generator was removed from the EUT, the generator was then retriggered for a new single discharge. For ungrounded product, a grounded carbon fibre brush with bleeder resistors (2x470 kΩ) in the grounding cable was used after each discharge to remove remnant electrostatic voltage.

For air discharge, a minimum of 10 single air discharges were applied to the selected test point for each such area.

8.1.3 Test Result

Direct Application of ESD

Direct Contact Discharge

Applied Voltage (kV)	No. of Discharge for each point	Result	Discharged Points
4	20	Pass	Accessible metal parts of the EUT Conductive substrate with coating which is not declared to be insulating

Direct Air Discharge

Applied Voltage (kV)	No. of Discharge for each point	Result	Discharged Points
2, 4, 8	20	Pass	All accessible points where contact discharge cannot be applied such as Displays, Indicators light, Keyboard, Button, Switch, Knob, Air gap, Slots, Hole and so on

TEST REPORT

Indirect Application of ESD

Horizontal Coupling Plane under the EUT

Applied Voltage (kV)	No. of Discharge for each point	Result	Discharged Point
4	20	Pass	At the front edge of each HCP opposite the centre point of each unit of the EUT

Vertical Coupling Plane beside the EUT

Applied Voltage (kV)	No. of Discharge for each point	Result	Discharged Point
4	20	Pass	The centre of the vertical edge of the coupling plane

8.2 EN 61000-4-6(Pursuant to EN 61000-6-1) Injected Current (0.15 MHz to 80 MHz)

Tested Port: AC power DC power Functional earth Signal/Control

Performance criterion: A

Test Result: Pass

8.2.1 Block Diagram of Test Setup

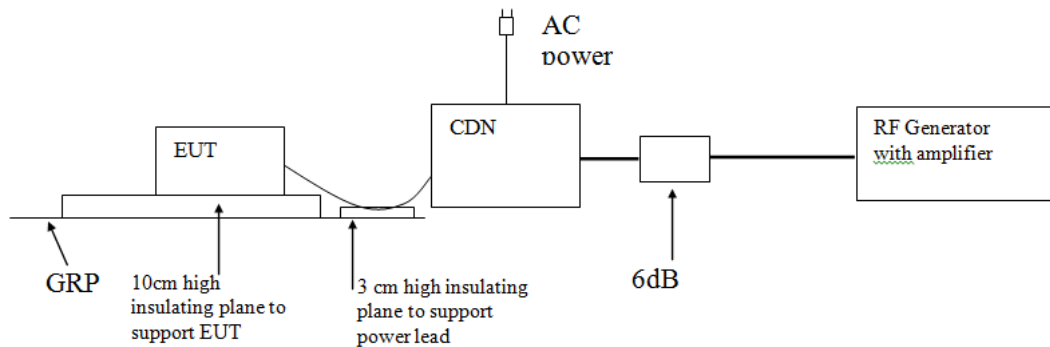

8.2.2 Test Setup and Procedure

The EUT was placed on an insulating support of 0.1m height above a ground reference Plane, arranged and connected to satisfy its functional requirement.

All relevant cables were provided with the appropriate coupling and decoupling devices at a distance between 0.1m and 0.3m from the projected geometry of the EUT on an insulating support of 0.03m height above the ground reference plane.

Test voltage was verified before each testing though power meter combined in the RF generator with AMP.

TEST REPORT

Dwell time was set to 3s and step was set as 1% to keep sufficient response time for EUT.
The frequency from 0.15MHz to 80MHz was checked.
The frequency range is scanned as specified. However, when specified in Annex A of EN 61000-6-1, an additional comprehensive functional test shall be carried out at a limited number of frequencies. The selected frequencies for conducted test are: 0,2; 1; 7,1; 13,56; 21; 27,12 and 40,68 MHz ($\pm 1\%$).

8.2.3 Test Result

Port	Frequency (MHz)	Level	Result
A.C. Power Lines	0.15 to 80	3V (r.m.s.)	Pass
D.C. Power Lines	0.15 to 80	3V (r.m.s.)	Pass
Signal Lines	0.15 to 80	3V (r.m.s.)	N/A
Control Lines	0.15 to 80	3V (r.m.s.)	N/A
Functional Earth	0.15 to 80	3V (r.m.s.)	N/A

8.3 EN 61000-4-4(Pursuant to EN 61000-6-1) Electrical Fast Transient/Burst

Tested Port: AC power DC power Functional earth Signal/Control

Performance criterion: B

Test Result: Pass

8.3.1 Block Diagram of Test Setup

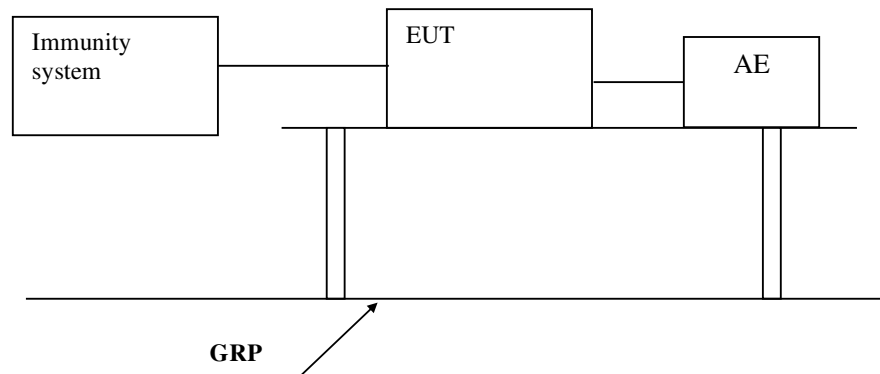

8.3.2 Test Setup and Procedure

The EUT was placed on a 0.1m high wooden table, standing on the ground reference plane 3m by 2m in size, made by steel 1mm thick.

TEST REPORT

The distance between the EUT and any other of the metallic surface except the GRP was greater than 0.5m.

The mains lead excess than 0.5m was folded to avoid a flat coil and situated at a distance of 0.1m above the ground reference plane to insure the distance between the coupling device and the EUT was 0.5m.

The EUT was arranged and connected to satisfy its functional requirement and supplied by the coupling-decoupling network. Repetition Frequency was 5 kHz.

8.3.3 Test Result

Level	Polarity	A.C. Power supply line and functional earth terminal	D.C. Power Lines, Signal Line & Control Line
0.5 kV	+	N/A	N/A
0.5 kV	-	N/A	N/A
1 kV	+	Pass	N/A
1 kV	-	Pass	N/A

8.4 EN 61000-4-5(Pursuant to EN 61000-6-1) Surge Immunity

Tested Port: AC power DC power

Performance criterion: B

Test Result: Pass

8.4.1 Block Diagram of Test Setup

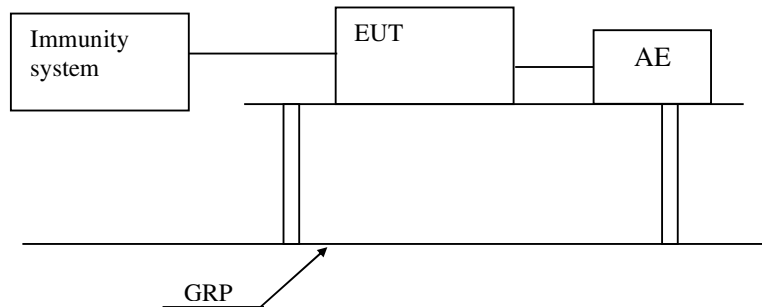

8.4.2 Test Setup and Procedure

The surge was applied to the EUT power supply terminals via the capacitive coupling network.

Decoupling networks were required in order to avoid possible adverse effects on equipment not under test that might be powered by the same lines and to provide sufficient decoupling impedance to the surge wave so that the specified wave might be developed on the lines under test.

TEST REPORT

The EUT was arranged and connected according to its functional requirements.

The EUT was placed on a 0.1m high wooden support above the GRP), supplied by the coupling-decoupling network, and arranged and connected to satisfy its functional requirement. The power cord between the EUT and the coupling/decoupling network was less than 2 meters.

8.4.3 Test Result

Tested Port	Level	Result
AC power	Line to line $\pm 0.5\text{kV}$, $\pm 1\text{kV}$	Pass
AC power	Line to earth $\pm 0.5\text{kV}$, $\pm 1\text{kV}$, $\pm 2\text{kV}$	Pass
DC power	Line to earth $\pm 0.5\text{kV}$	Pass

8.5 EN 61000-4-11(Pursuant to EN 61000-6-1) Voltage Dips and Interruptions

Tested Port: AC power

Test Result: Not Applicable

Remark: the test only applicable to the AC input port.

TEST REPORT

8.6 EN 61000-4-3(Pursuant to EN 61000-6-1) Radiated Electromagnetic Field Immunity

Performance criterion: A

Test Result: Pass

8.6.1 Block Diagram of Test Setup

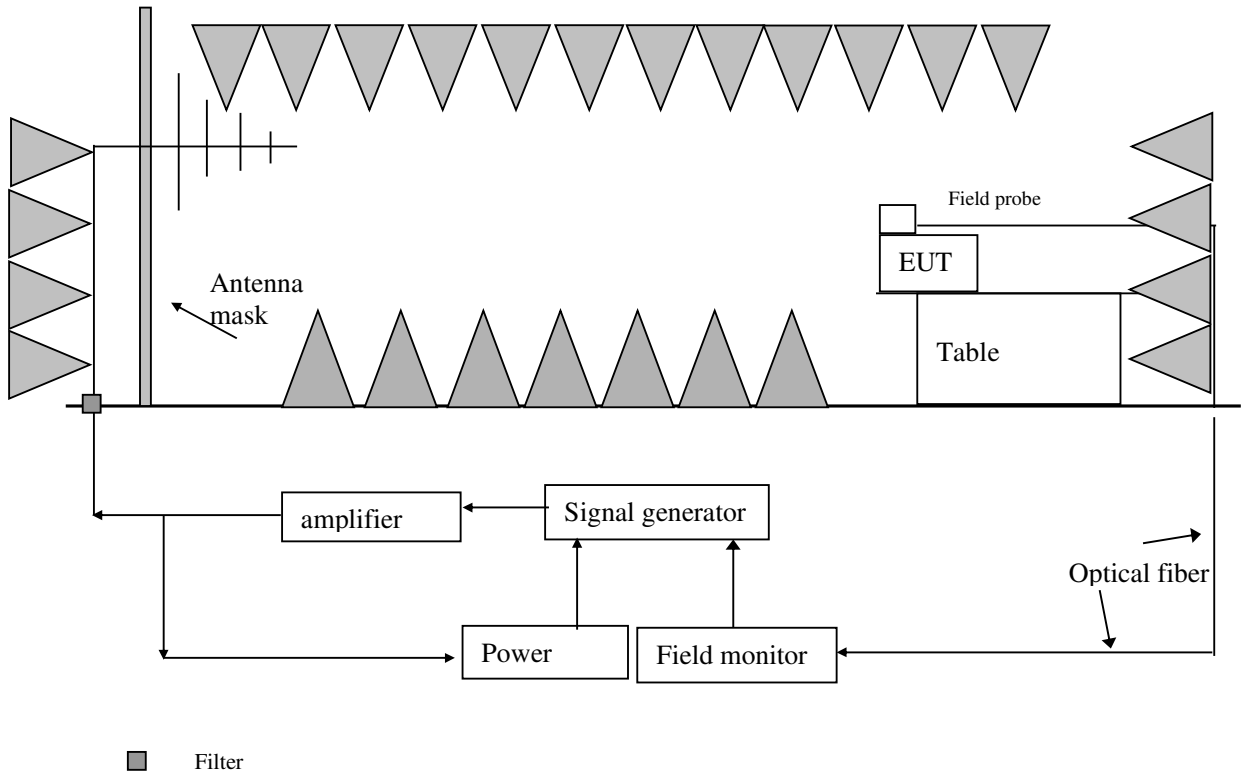

TEST REPORT

8.6.2 Test Setup and Procedure

The test was conducted in a fully anechoic chamber to maintain a uniform field of sufficient dimensions with respect to the EUT, and also in order to comply with various national and international laws prohibiting interference to radio communications.

The equipment was placed in the test facility on a non-conducting table 0.8m high (for floor standing EUT, is placed on a non-conducting support 0.1m height).

The EUT was placed on the uniform calibrated plane which is 3V/m and 1V/m EM field.

For all ports connected to EUT, manufacturer specified cable type and length was used, for those cables no specification, unshielded cable applied. Wire was left exposed to the electromagnetic field for a distance of 1 m from the EUT.

The EUT was arranged and connected according to its functional requirements

Before testing, the intensity of the established field strength had been checked by placing the field sensor at a calibration grid point, and with the field generating antenna and cables in the same positions as used for the calibration, the forward power needed to give the calibrated field strength was measured. Spot checks was made at a number of calibration grid points over the frequency range 80 to 1000 MHz and 1.4 to 2.7 GHz, both polarizations was checked. After calibration, the EUT was initially placed with one face coincident with the calibration plane.

The frequency range was swept from 80 to 1000MHz and 1.4 to 2.7 GH, with the signal 80% amplitude modulated with a 1 kHz sinewave, pausing to adjust the r.f. signal level. The dwell time at each frequency was 3s so as that the EUT to be exercised and be able to respond.

The step size was 1% of the fundamental with linear interpolation between calibrated points. Test was performed with the generating antenna facing each of the four sides of the EUT.

8.6.3 Test Result

Frequency (MHz)	Exposed Side	Field Strength (V/m)	Result
80 to 1000	Front	3 V/m (r.m.s.)	Pass
80 to 1000	Left	3 V/m (r.m.s.)	Pass
80 to 1000	Rear	3 V/m (r.m.s.)	Pass
80 to 1000	Right	3 V/m (r.m.s.)	Pass

TEST REPORT

Frequency (MHz)	Exposed Side	Field Strength (V/m)	Result
1.4 to 2.0	Front	3 V/m (r.m.s.)	Pass
1.4 to 2.0	Left	3 V/m (r.m.s.)	Pass
1.4 to 2.0	Rear	3 V/m (r.m.s.)	Pass
1.4 to 2.0	Right	3 V/m (r.m.s.)	Pass

Frequency (MHz)	Exposed Side	Field Strength (V/m)	Result
2.0 to 2.7	Front	1 V/m (r.m.s.)	Pass
2.0 to 2.7	Left	1 V/m (r.m.s.)	Pass
2.0 to 2.7	Rear	1 V/m (r.m.s.)	Pass
2.0 to 2.7	Right	1 V/m (r.m.s.)	Pass

TEST REPORT

8.7 EN 61000-4-8(Pursuant to EN 61000-6-1) Power Frequency Magnetic Field Immunity

Tested Port: Enclosure

Performance criterion: A

8.7.1 Block Diagram of Test Setup

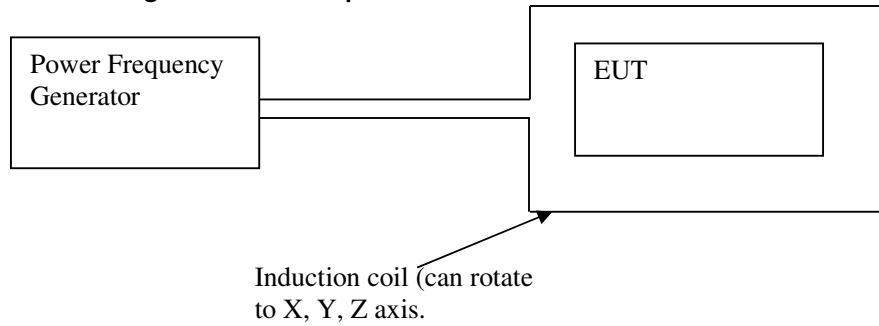

8.7.2 Test Setup and Procedure

Put EUT into center of induction coil (with suitable dimensions) in the testing.

For tabletop equipment:

The EUT was placed on a big enough wooden desk with height of 0.8m and operating as intended.

The equipment shall be subjected to the test magnetic field by using the induction coil of standards (1m*1m).

The induction coil shall be rotated by 90° in order to expose the EUT to the test field with different orientations.

For Floor-standing equipment:

The EUT was placed on big enough wooden desk with height of 0.1m and operating as intended.

The equipment shall be subjected to the test magnetic field by using induction coils of suitable dimensions; the test shall be repeated by moving and shifting the induction coils, in order to test the whole volume of the EUT for each orthogonal direction. The test shall be repeated with the coil shifted to different position along the side of the EUT, in steps corresponding to 50% of the shortest side of the coil.

The induction coil shall then be rotated by 90° in order to expose the EUT to the test field with different orientations and the same procedure followed.

8.7.3 Test Result

TEST REPORT

Mains frequency: 50 Hz

60 Hz

Orientations of induction coil	Magnetic Field Strength (A/m)	Result
X	3 A/m	Pass
Y	3 A/m	Pass
Z	3 A/m	Pass

TEST REPORT

9. APPENDIX I - PHOTOS OF TEST SETUP

Conducted disturbance voltage at mains ports



Radiated emission (30 MHz–1000 MHz)



TEST REPORT

Harmonic of current/Flicker



Inject current immunity



TEST REPORT

Radiated EM field immunity

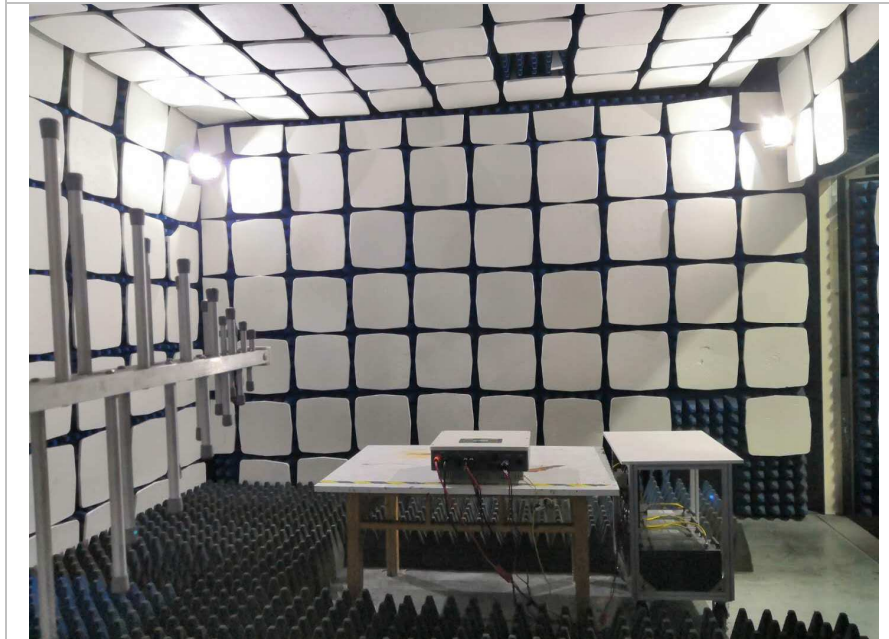

Surge Immunity



TEST REPORT

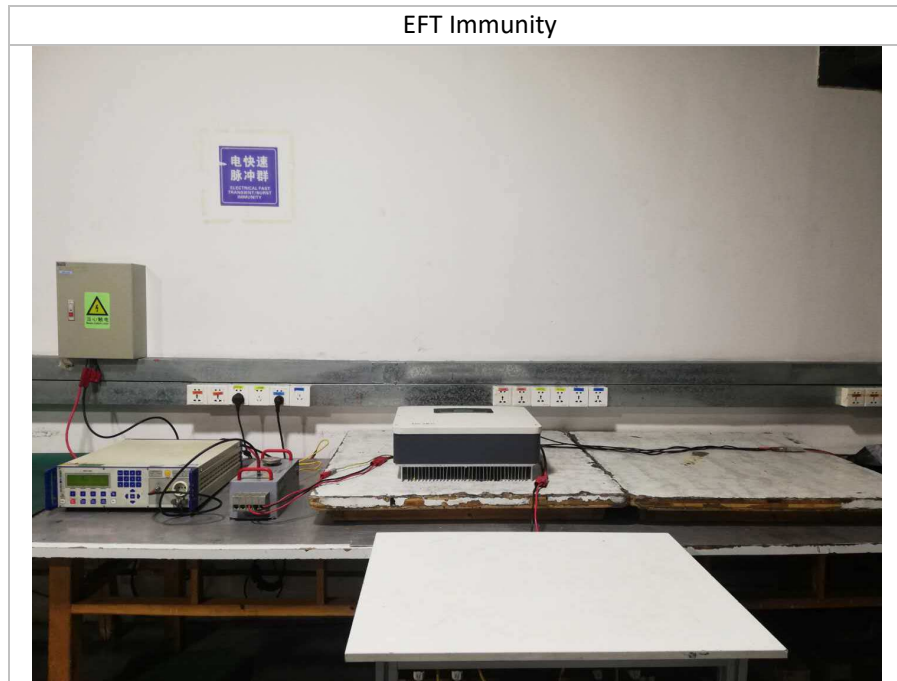

TEST REPORT

10. APPENDIX II – PHOTOS OF EUT

Appendix 1: Photos



Overview



Bottom view

TEST REPORT

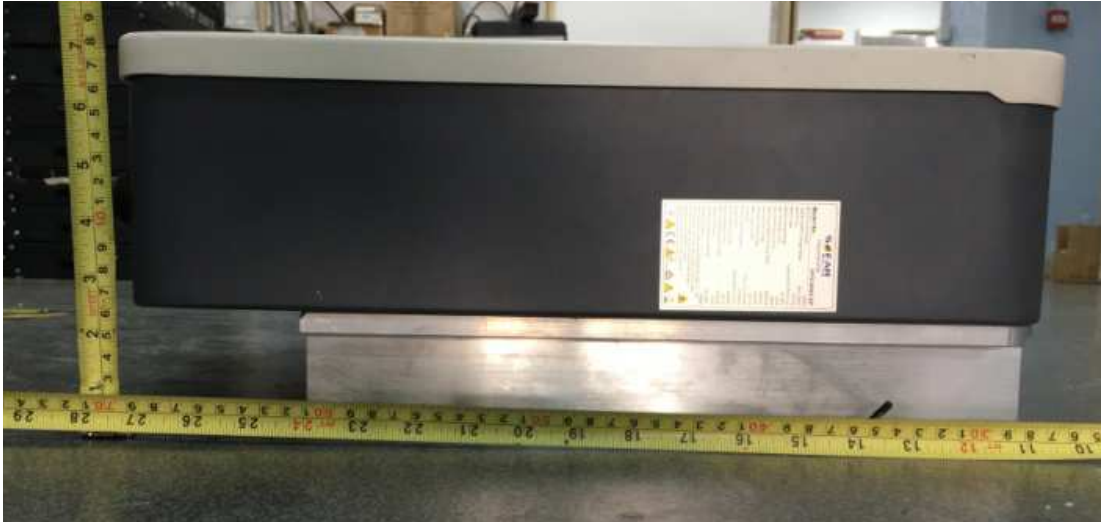

Side view



Connection view

TEST REPORT

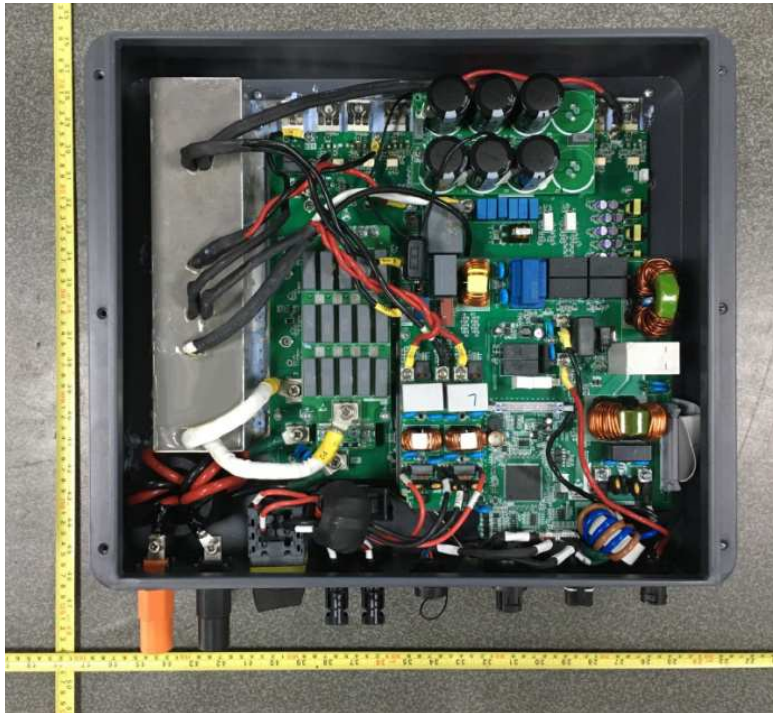

Internal view for model HYD 4000-EP, HYD 3600-EP, HYD 5500-EP, HYD 3000-EP

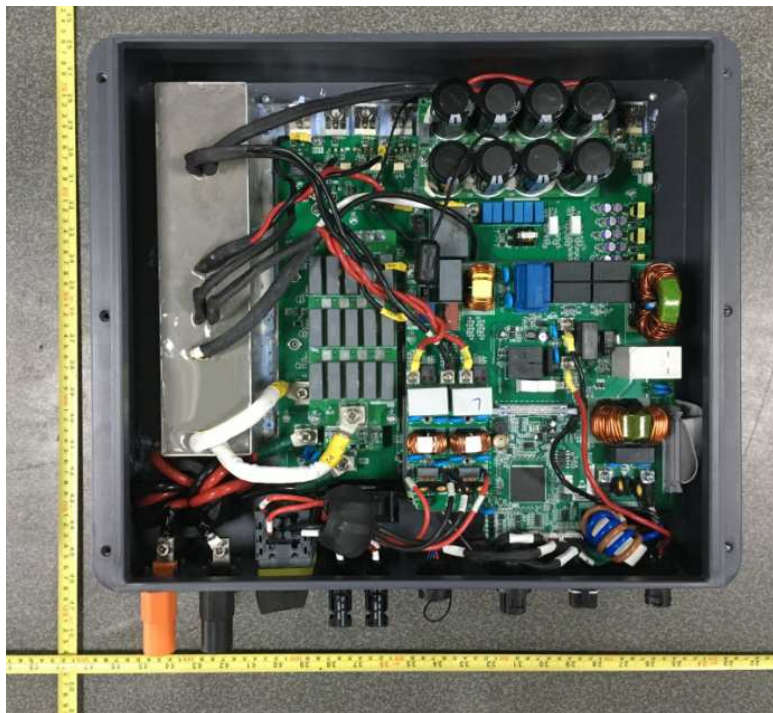

Internal view for model HYD 4600-EP, HYD 5000-EP, HYD 6000-EP

TEST REPORT

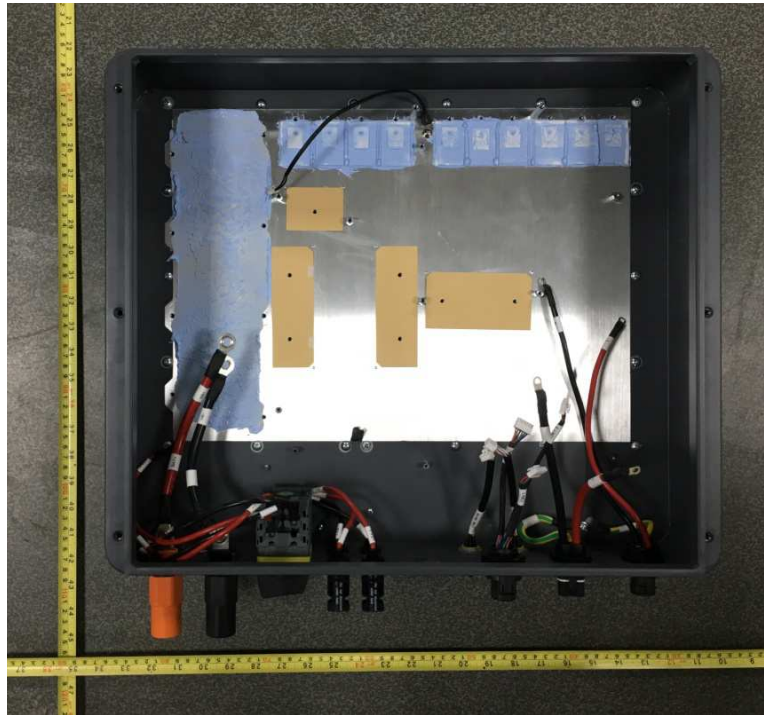

Internal view



Earthing view

TEST REPORT



Power board view (Components side)

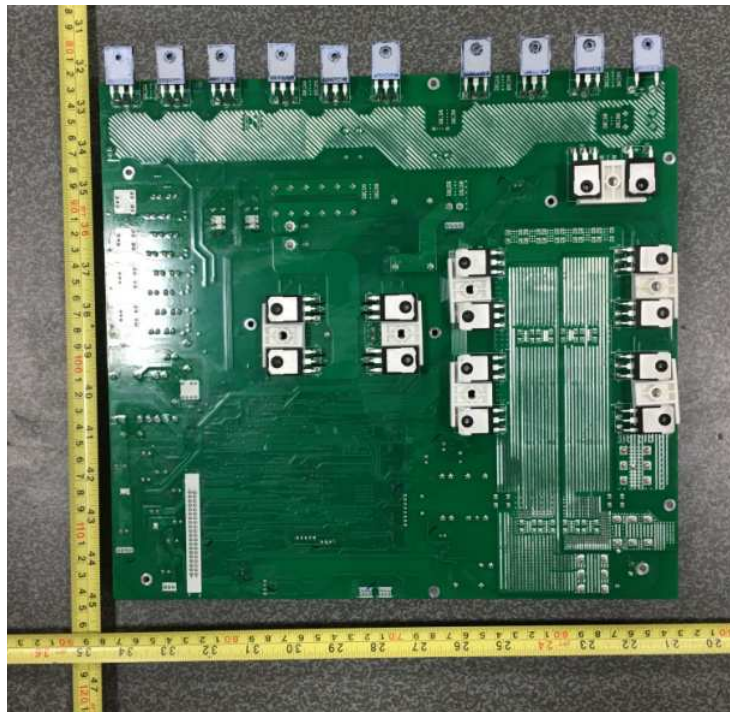

Power board view (Soldered side)

TEST REPORT

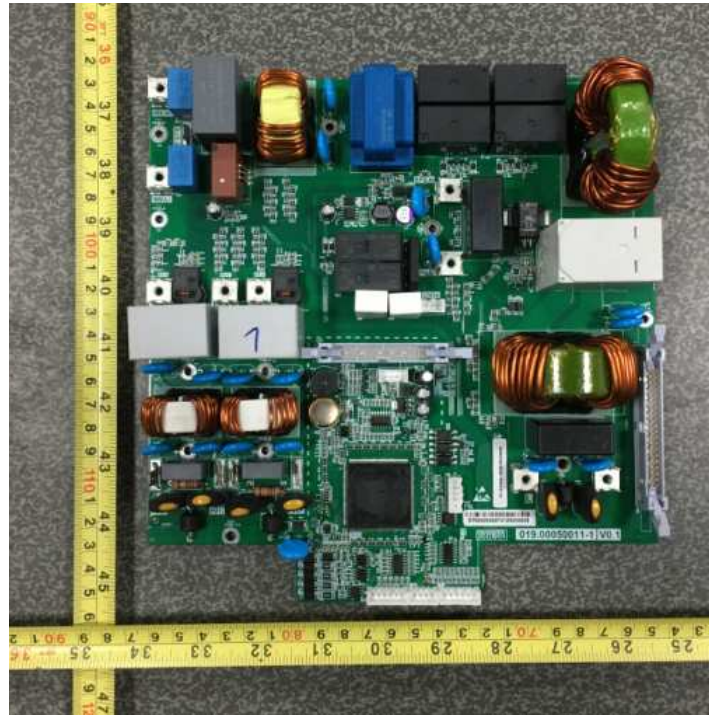

Input/output and connection board view (Components side)

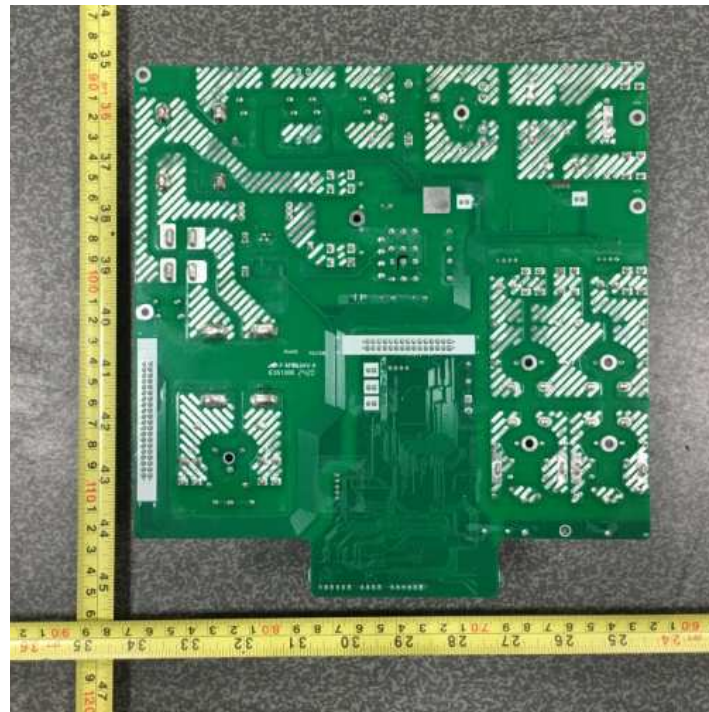

Input/output and connection board view (Soldered side)

TEST REPORT

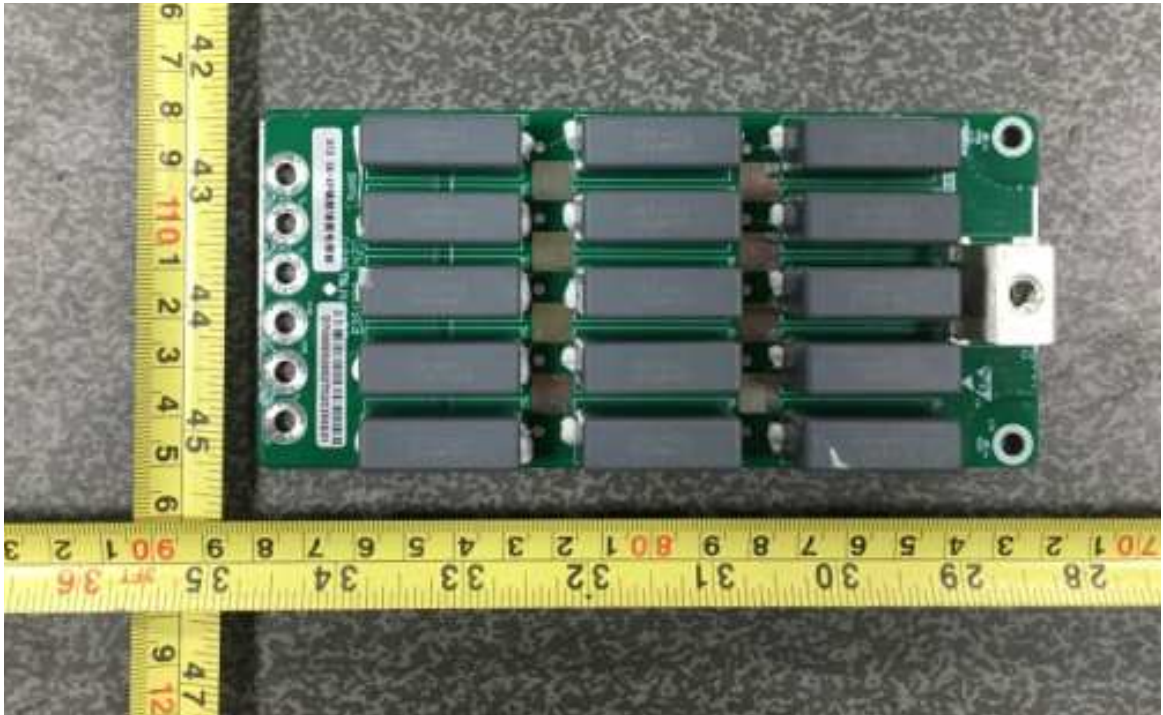

Filter board view (Components side)

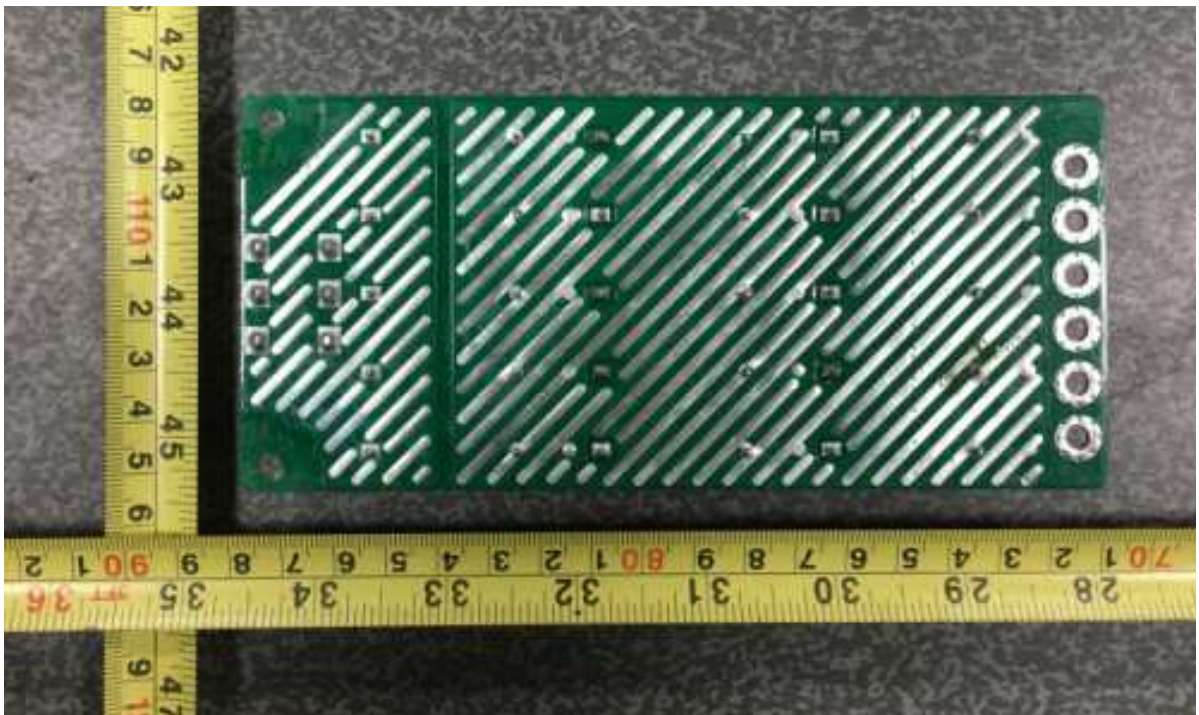

Filter board view (Soldered side)

TEST REPORT



Capacitor board for model HYD 4600-EP, HYD 5000-EP, HYD 5500-EP, HYD 6000-EP

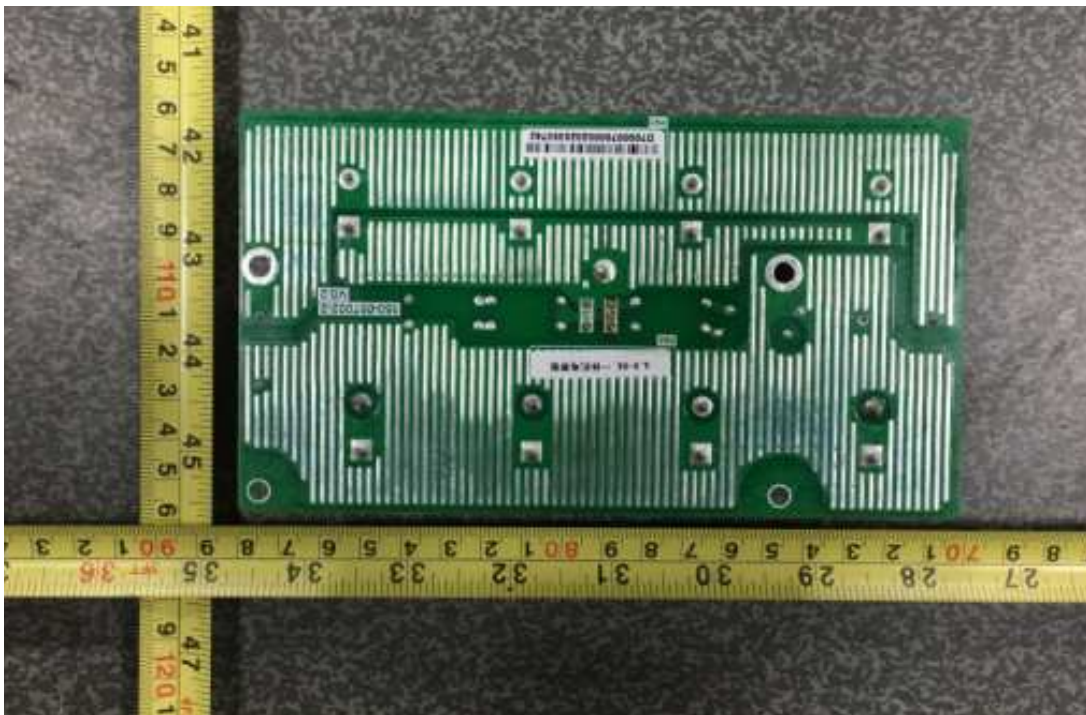

Capacitor board for model HYD 4600-EP, HYD 5000-EP, HYD 5500-EP, HYD 6000-EP

TEST REPORT

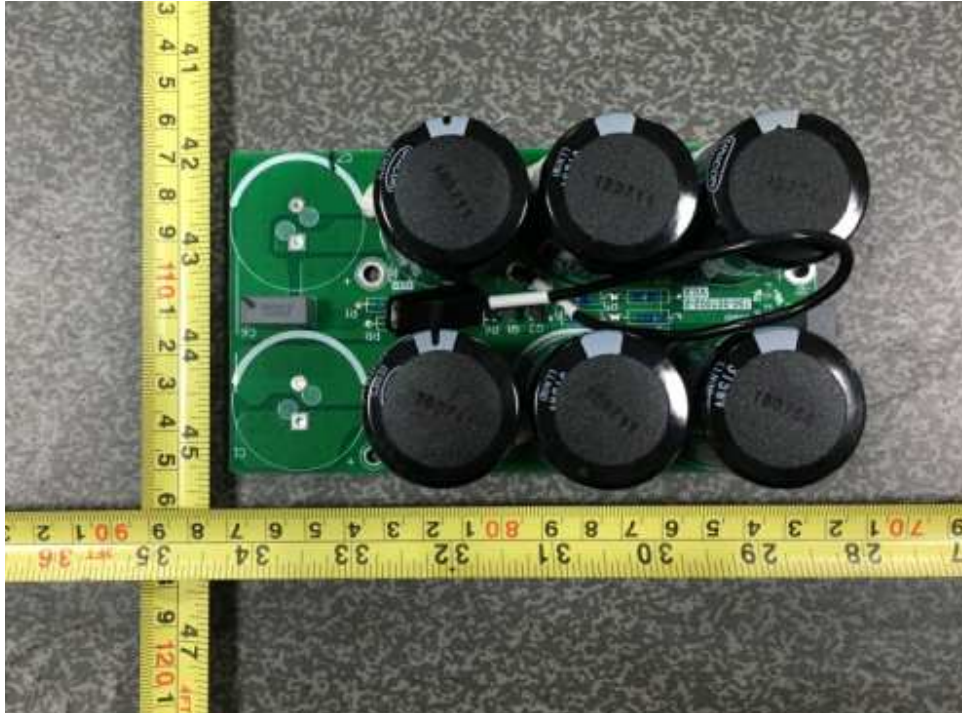

Capacitor board for model HYD 3600-EP, HYD 3000-EP, HYD 4000-EP

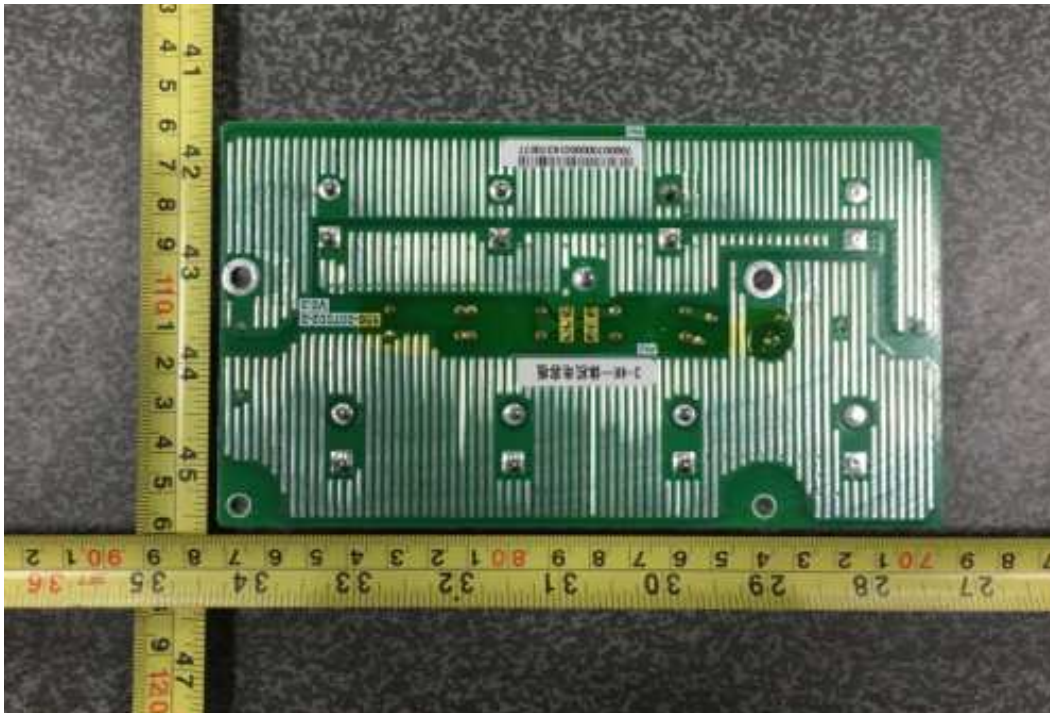

Capacitor board for model HYD 3600-EP, HYD 3000-EP, HYD 4000-EP

TEST REPORT

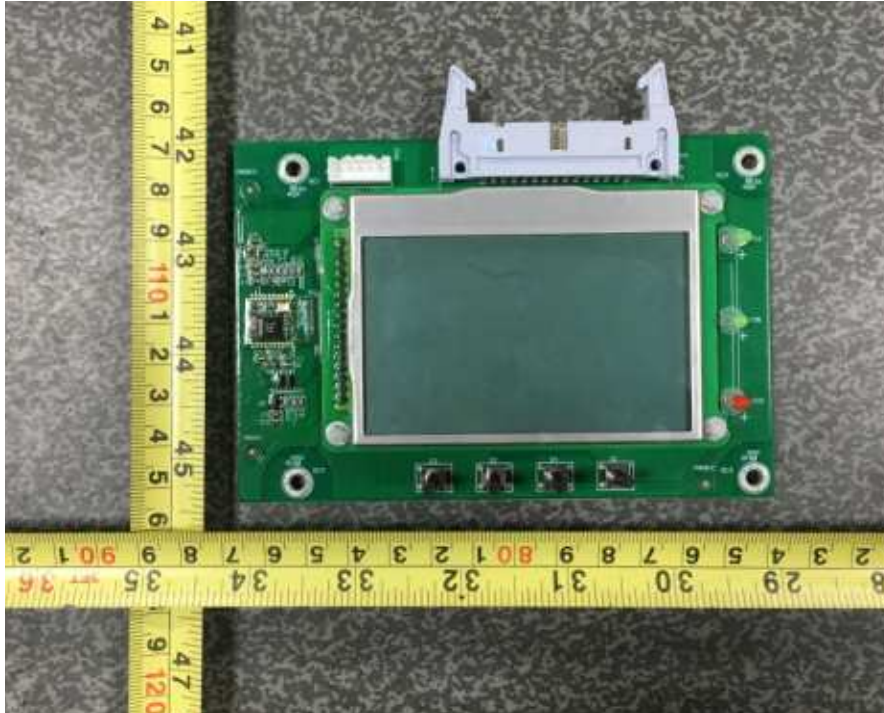

Display board view

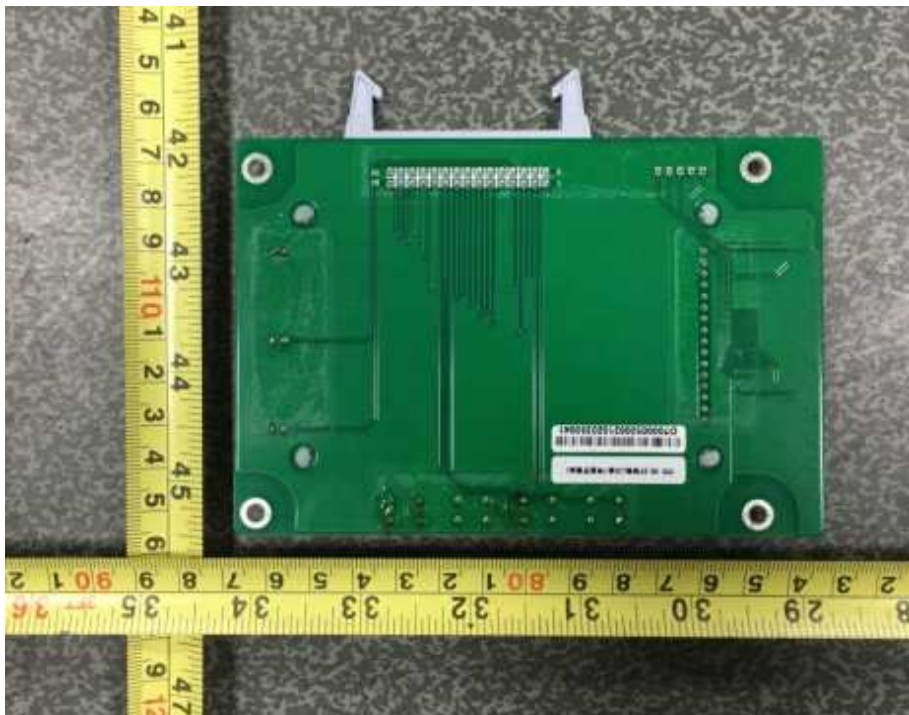

Display board view

*****End of Report*****